

# Panasonic®



## Operating Instructions

### DVD/VHS Home Theater Sound System

Model No. **SC-HT820V**



INTRO



SETUP



DVD



VHS



RADIO & OTHERS



INFO

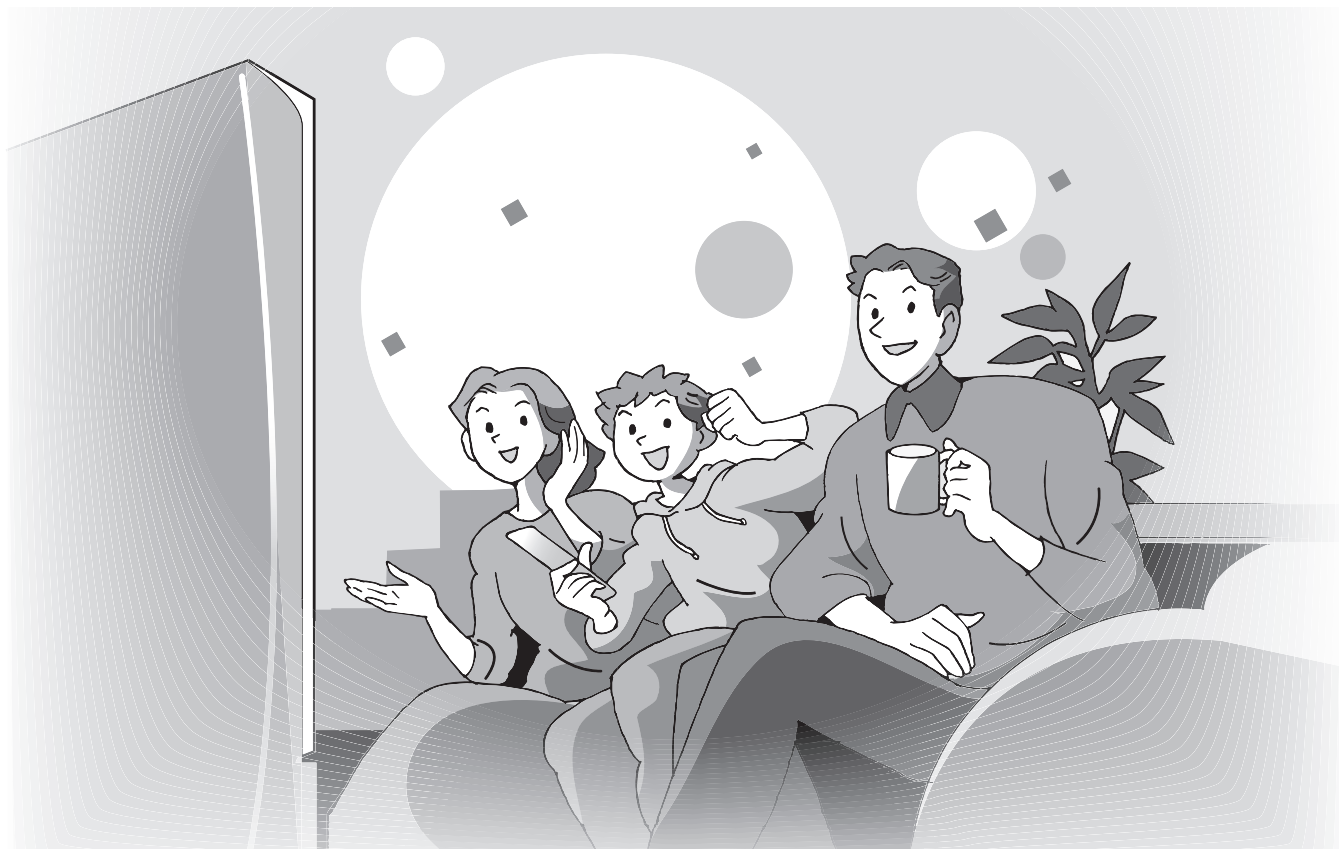

### Dear customer

Thank you for purchasing this product. For optimum performance and safety, please read these instructions carefully.

Before connecting, operating or adjusting this product, please read these instructions completely. Please keep this manual for future reference.



**SUPER DRIVE**

### Region number

The player plays DVD-Video marked with labels containing the region number "1" or "ALL".

Example:



For U.S.A.



As an ENERGY STAR® Partner, Panasonic has determined that this product meets the ENERGY STAR® guidelines for energy efficiency.

For U.S.A. only

The warranty can be found on page 54.

For Canada only

The warranty can be found on page 55.

System	SC-HT820V
Main unit	SA-HT820V
Front and surround speakers	SB-FS520A
Center speaker	SB-PC820
Active subwoofer	SB-WA820

Operations in these instructions are described mainly with the remote control, but you can do the operations on the main unit if the controls are the same.

**CAUTION!**

DO NOT INSTALL OR PLACE THIS UNIT IN A BOOKCASE, BUILT-IN CABINET OR IN ANOTHER CONFINED SPACE. ENSURE THE UNIT IS WELL VENTILATED. TO PREVENT RISK OF ELECTRIC SHOCK OR FIRE HAZARD DUE TO OVERHEATING, ENSURE THAT CURTAINS AND ANY OTHER MATERIALS DO NOT OBSTRUCT THE VENTILATION VENTS.

**WARNING:**

TO REDUCE THE RISK OF FIRE, ELECTRIC SHOCK OR PRODUCT DAMAGE, DO NOT EXPOSE THIS APPARATUS TO RAIN, MOISTURE, DRIPPING OR SPLASHING AND THAT NO OBJECTS FILLED WITH LIQUIDS, SUCH AS VASES, SHALL BE PLACED ON THE APPARATUS.

**CAUTION!**

THIS PRODUCT UTILIZES A LASER. USE OF CONTROLS OR ADJUSTMENTS OR PERFORMANCE OF PROCEDURES OTHER THAN THOSE SPECIFIED HEREIN MAY RESULT IN HAZARDOUS RADIATION EXPOSURE. DO NOT OPEN COVERS AND DO NOT REPAIR YOURSELF. REFER SERVICING TO QUALIFIED PERSONNEL.

**THE FOLLOWING APPLIES ONLY IN THE U.S.A.**

**Note to CATV system installer:**

This reminder is provided to call the CATV system installer's attention to Article 820-40 of the NEC that provides guidelines for proper grounding and, in particular, specifies that the cable ground shall be connected to the grounding system of the building, as close to the point of cable entry as practical.

**THE FOLLOWING APPLIES ONLY IN THE U.S.A. CAUTION:**

This equipment has been tested and found to comply with the limits for a Class B digital device, pursuant to Part 15 of the FCC Rules.

These limits are designed to provide reasonable protection against harmful interference in a residential installation. This equipment generates, uses and can radiate radio frequency energy and, if not installed and used in accordance with the instructions, may cause harmful interference to radio communications. However, there is no guarantee that interference will not occur in a particular installation. If this equipment does cause harmful interference to radio or television reception, which can be determined by turning the equipment off and on, the user is encouraged to try to correct the interference by one or more of the following measures:

- Reorient or relocate the receiving antenna.
- Increase the separation between the equipment and receiver.
- Connect the equipment into an outlet on a circuit different from that to which the receiver is connected.
- Consult the dealer or an experienced radio/TV technician for help.

Any unauthorized changes or modifications to this equipment would void the user's authority to operate this device.

This device complies with Part 15 of the FCC Rules. Operation is subject to the following two conditions: (1) This device may not cause harmful interference, and (2) this device must accept any interference received, including interference that may cause undesired operation.

<b>CAUTION</b>	- LASER RADIATION WHEN OPEN. DO NOT STARE INTO BEAM. FDA 21 CFR 1 Class II
<b>CAUTION</b>	- VISIBLE AND INVISIBLE LASER RADIATION WHEN OPEN. AVOID EXPOSURE TO BEAM. IEC60825-11 Class 3b
<b>VARNING</b>	- SYNLIIG OCH OSYNLIIG LASERSTRÅLNING NÄR DENNA DEL ÄR ÖPPNAD. BETRÄKTA EJ STRÅLEN.
<b>ADVARSEL</b>	- SYNLIIG OG OSYNLIIG LASERSTRÅLNING VED ÅBNING. UNNGÅ UDSÆTTELSE FOR STRÅLING.
<b>ADVARSEL</b>	- SYNLIIG OG OSYNLIIG LASERSTRÅLNING NÄR DEKSEL ÅPNET. UNNGÅ EKSPONERING FÖR STRÅLEN.
<b>VARO!</b>	- AVATTAESSA OLET ALTIITIN NÄKYVÄÄ JA NÄKYMÄTÖN LASERSÄTELYLLE. ÄLÄ KATSO SÄTEESEEN.
<b>VORSICHT</b>	- SICHTBARE UND UNSICHTBARE LASERSTRÄHLUNG, WENN ABDECKUNG GEÖFFNET. NICHT DEM STRAHL AUSSETZEN.
<b>ATTENTION</b>	- RAYONNEMENT LASER VISIBLE ET INVISIBLE EN CAS D'OUVERTURE. EXPOSITION DANGEREUSE AU FASCEAU!
<b>注意</b>	- 打开時可见及不可见激光辐射。避免激光照射。
<b>注意</b>	- ここを開くと可視及び不可視レーザー光が出ます。ビームを見たり、触れたりしないで下さい。 RQLXS0054

(Inside of product)

**Before moving the unit, ensure the disc trays and video cassette slot are empty.**

Failure to do so will risk severely damaging the discs, video cassette tape and the unit.

**Avoid use or placing highly magnetic devices (Speakers etc.) or devices that emit strong electro-magnetic waves (mobile telephones etc.) near the main unit.**

- The above may result in problems with audio and video, and recorded content may be lost.
- Be extra cautious when you are using a plasma television, keeping these devices as far away as possible.

**Stacking**

Place the unit in a horizontal position, and do not place anything heavy on it.



**CAUTION: TO REDUCE THE RISK OF ELECTRIC SHOCK, DO NOT REMOVE SCREWS. NO USER-SERVICEABLE PARTS INSIDE. REFER SERVICING TO QUALIFIED SERVICE PERSONNEL.**



The lightning flash with arrowhead symbol, within an equilateral triangle, is intended to alert the user to the presence of uninsulated "dangerous voltage" within the product's enclosure that may be of sufficient magnitude to constitute a risk of electric shock to persons.



The exclamation point within an equilateral triangle is intended to alert the user to the presence of important operating and maintenance (servicing) instructions in the literature accompanying the appliance.

- Operating while there is condensation in the unit or on the cassette tape may cause the tape to catch upon the cylinder resulting in the tape being cut, or not being able to remove the cassette tape from the unit. The unit also may not work properly if the unit's cylinder or heads have been damaged.
- Wait 1-2 hours for condensation to evaporate (do not operate the unit during this time).

# Table of contents



**Accessories** ..... 4  
 The remote control ..... 4  
**IMPORTANT SAFETY INSTRUCTIONS** ..... 5  
**Tape information** ..... 5  
**Discs that can be played** ..... 6

**Control reference guide** ..... 7  
 Remote control—common buttons ..... 7  
 Remote control—DVD operation ..... 7  
 Remote control—VHS operation ..... 8  
 Remote control—TUNER operation ..... 8  
 Main unit and subwoofer ..... 9  
 Main unit display ..... 9



**Simple setup**  
**STEP1 Locating** ..... 10  
**STEP2 Connecting speakers with the subwoofer** .. 11  
**STEP3 Television** ..... 12  
 Basic connection ..... 12  
 For better video from DVD ..... 13

**STEP4 Radio and system connection** ..... 14  
**STEP5 Plug-in Auto Tuning** ..... 15  
**STEP6 Operating the television** ..... 16  
**STEP7 DVD QUICK SETUP** ..... 17



**Basic play** ..... 18  
**Convenient functions** ..... 20  
 Position memory ..... 20  
 Zoom ..... 20  
 Subtitle ..... 20  
 Audio ..... 20  
 Multi Re-master ..... 21  
 Page skip ..... 21  
 Sequential play (CD Mode) ..... 21  
 Quick replay ..... 21  
 All group/Program/Random play ..... 22  
 Repeat play ..... 23

**Using navigation menus** ..... 24  
 Playing data discs ..... 24  
 Playing HighMAT discs ..... 25  
 Playing the programs ..... 25  
 Playing a play list ..... 25  
**Using On-Screen Menus** ..... 26  
 Main menus ..... 26  
 Other settings ..... 27  
**Changing the player settings** ..... 28  
 Changing the delay time (Speaker Setting) ..... 29



**Playback** ..... 30  
 Picture mode ..... 31  
 Repeat play ..... 31  
 Manual tracking ..... 31  
 Vertical locking adjustment ..... 31  
**Manual recording** ..... 32  
 Recording the television ..... 32  
 Using another source while recording ..... 33  
 Recording from other equipment ..... 33  
**Timer recording** ..... 34

**Finding programs with the Jet Navigator and VHS Index Search System (VISS)** ..... 36  
 Saving Jet Navigator data ..... 36  
 Using the Jet Navigator to find programs ..... 36  
 Finding programs—VHS Index Search System (VISS) .. 37  
**Changing settings** ..... 38  
 LANGUAGE ..... 38  
 CLOCK SET ..... 38  
 CHANNEL SET ..... 39  
 OPTION ..... 40  
 On-screen display ..... 41  
 Changing audio ..... 41



**The radio** ..... 42  
 Automatic presetting ..... 42  
 Selecting the preset channels ..... 42  
 Manual tuning ..... 42  
 Optional FM antenna connection ..... 43  
**Sound field and sound quality** ..... 44  
 Sound Field Control ..... 44  
 Super Surround ..... 44  
 Center Focus ..... 44  
 Dolby Pro Logic II ..... 44  
 Dolby Pro Logic ..... 44

Custom Sound Memory ..... 45  
 Down-mixing ..... 45  
 Subwoofer level ..... 45  
 Speaker level adjustments ..... 45  
**Other convenient features** ..... 46  
 The sleep timer ..... 46  
 Muting ..... 46  
 Using headphones ..... 46



**Other speaker setup options** ..... 47  
 Attaching to a wall ..... 47  
 Fitting speaker stands (optional) ..... 47  
**Optional connections** ..... 47  
 Listening to an external source/  
 Recording to other equipment ..... 47  
 Connecting a cable TV box/satellite receiver ..... 48  
 If the antenna connector doesn't match ..... 49

**Troubleshooting guide** ..... 50  
**Maintenance** ..... 52  
**Specifications** ..... 53  
**Limited Warranty (ONLY FOR U.S.A.)** ..... 54  
**Limited Warranty (ONLY FOR CANADA)** ..... 55  
**Product Service** ..... 55  
**Index** ..... Back cover



# Accessories



Please check and identify the supplied accessories. Use numbers indicated in parentheses when asking for replacement parts.

(Only for U.S.A.)









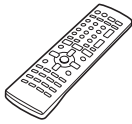

To order accessories, refer to "Accessory Purchases" on page 54.

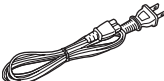
(Only for Canada)

To order accessories, call the dealer from whom you have made your purchase.

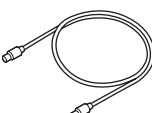

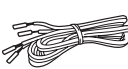
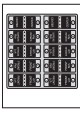
INTRO

- 1 Remote control (EUR7722X20) 
- 2 Batteries for remote control 
- 2 AC power supply cord (K2CB2CB00006) 
- 1 AM loop antenna (N1DAAA00002) 
- 1 FM indoor antenna (RSA0007-L) 
- 1 Video cable (RJL1P016B15A) 
- 1 75 Ω coaxial cable (VJA1125) 
- 1 System cable (K1HA25HA0001) 
- 5 Speaker cables  
3×4-m (13-foot) cables (REE1203A-J)  
2×10-m (33-foot) cables (REE1203C-J) 
- 1 Sheet of speaker-cable stickers 
- 1 Antenna plug (K2RC021B0001) 

**Note**

The included AC power supply cord is for use with this unit only. Do not use it with other equipment.

# The remote control

Remote control

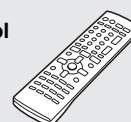

Batteries



**Batteries**

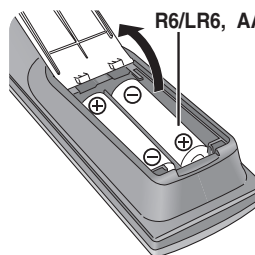

- Insert so the poles (+ and -) match those in the remote control.
- Do not use rechargeable type batteries.

**Do not:**

- mix old and new batteries.
  - use different types at the same time.
  - heat or expose to flame.
  - take apart or short circuit.
  - attempt to recharge alkaline or manganese batteries.
  - use batteries if the covering has been peeled off.
- Mishandling of batteries can cause electrolyte leakage which can damage items the fluid contacts and may cause a fire.

Remove if the remote control is not going to be used for a long period of time. Store in a cool, dark place.

**Use**

Aim at the sensor (→ page 9), avoiding obstacles, at a maximum range of 7 m (23 feet) directly in front of the unit.

**User memo:**

<b>DATE OF PURCHASE</b> _____ <b>DEALER NAME</b> _____ <b>DEALER ADDRESS</b> _____ _____ <b>TELEPHONE NUMBER</b> _____
--

<p>The model number and serial number of this product can be found on either the back or the bottom of the unit. Please note them in the space provided below and keep for future reference.</p> <b>MODEL NUMBER</b> _____ SC-HT820V _____ <b>SERIAL NUMBER</b> _____
--

# IMPORTANT SAFETY INSTRUCTIONS

Read these operating instructions carefully before using the unit. Follow the safety instructions on the unit and the applicable safety instructions listed below. Keep these operating instructions handy for future reference.

- 1) Read these instructions.
- 2) Keep these instructions.
- 3) Heed all warnings.
- 4) Follow all instructions.
- 5) Do not use this apparatus near water.
- 6) Clean only with dry cloth.
- 7) Do not block any ventilation openings. Install in accordance with the manufacturer's instructions.
- 8) Do not install near any heat sources such as radiators, heat registers, stoves, or other apparatus (including amplifiers) that produce heat.
- 9) Do not defeat the safety purpose of the polarized or grounding-type plug. A polarized plug has two blades with one wider than the other. A grounding-type plug has two blades and a third grounding prong. The wide blade or the third prong are provided for your safety. If the provided plug does not fit into your outlet, consult an electrician for replacement of the obsolete outlet.
- 10) Protect the power cord from being walked on or pinched particularly at plugs, convenience receptacles, and the point where they exit from the apparatus.
- 11) Only use attachments/accessories specified by the manufacturer.
- 12) Use only with the cart, stand, tripod, bracket, or table specified by the manufacturer, or sold with the apparatus. When a cart is used, use caution when moving the cart/apparatus combination to avoid injury from tip-over. 
- 13) Unplug this apparatus during lightning storms or when unused for long periods of time.
- 14) Refer all servicing to qualified service personnel. Servicing is required when the apparatus has been damaged in any way, such as power-supply cord or plug is damaged, liquid has been spilled or objects have fallen into the apparatus, the apparatus has been exposed to rain or moisture, does not operate normally, or has been dropped.

INTRO

## Tape information

### ■ Tapes

- You can use tapes with the VHS and S-VHS marks, but this unit is unable to make full use of the characteristics of S-VHS tapes.
- Break out the tape's tab to prevent accidental erasure. Cover the hole with a double layer of adhesive tape when you want to use the tape for recording again.

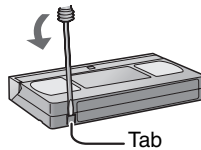

### ■ S-VHS Quasi Playback (SQPB)

You can play tapes recorded with the S-VHS system, however some noise may occur with some types and this unit cannot take advantage of S-VHS's high resolution. This unit cannot make S-VHS recordings.

### ■ Tape care

Poor quality or damaged tapes can cause the heads to become dirty and malfunction. Store your tapes carefully and discard when they become dirty or damaged.

Never use tapes on which juice has been spilt or those that are extremely damaged since this will not only cause the heads to become dirty, but will also make the unit malfunction.

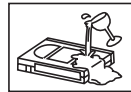

## Listening caution



Selecting fine audio equipment such as the unit you've just purchased is only the start of your musical enjoyment. Now it's time to consider how you can maximize the fun and excitement your equipment offers. This manufacturer and the Electronic Industries Association's Consumer Electronics Group want you to get the most out of your equipment by playing it at a safe level. One that lets the sound come through loud and clear without annoying blaring or distortion—and, most importantly, without affecting your sensitive hearing.

We recommend that you avoid prolonged exposure to excessive noise.

Sound can be deceiving. Over time your hearing "comfort level" adapts to higher volumes of sound. So what sounds "normal" can actually be loud and harmful to your hearing.

Guard against this by setting your equipment at a safe level BEFORE your hearing adapts.

To establish a safe level:

- Start your volume control at a low setting.
- Slowly increase the sound until you can hear it comfortably and clearly, and without distortion.

Once you have established a comfortable sound level:

- Set the dial and leave it there.

Taking a minute to do this now will help to prevent hearing damage or loss in the future. After all, we want you listening for a lifetime.

# Discs that can be played



Disc	Logo	Indication in these operating instructions	Remarks
DVD-RAM		<b>RAM</b>	Recorded using Version 1.1 of the Video Recording Format (a unified video recording standard). <ul style="list-style-type: none"> <li>Recorded with DVD video recorders, DVD video cameras, personal computers, etc.</li> <li>Remove discs from their cartridges before use.</li> </ul>
		<b>JPEG</b>	Recorded using the DCF (Design rule for Camera File system) standard. <ul style="list-style-type: none"> <li>Recorded with Panasonic DVD-Video recorders</li> <li>To play JPEG files, select "Play as Data Disc" in Other Menu (→ page 27)</li> </ul>
DVD-Audio		<b>DVD-A</b>	—
		<b>DVD-V</b>	Some DVD-Audio discs contain DVD-Video content. To play DVD-Video content, select "Play as DVD-Video" in Other Menu (→ page 27)
DVD-Video		<b>DVD-V</b>	—
DVD-R		<b>DVD-V</b>	Panasonic DVD-R recorded and finalized* on a Panasonic DVD-Video recorders or DVD-Video cameras are played as DVD-Video on this unit.
Video CD		<b>VCD</b>	—
SVCD			Conforming to IEC62107
CD		<b>CD</b>	This unit is compatible with HDCD. HDCD-encoded CDs sound better because they are encoded with 20 bits, as compared with 16 bits for all other CDs. <ul style="list-style-type: none"> <li>During HDCD play, "HDCD" lights on the unit's display.</li> </ul>
CD-R CD-RW	—	<b>WMA</b> <b>MP3</b> <b>JPEG</b> <b>CD</b> <b>VCD</b>	<ul style="list-style-type: none"> <li>This unit can play CD-R/RW (audio recording disc) recorded with the formats on the left. Close the sessions or finalize* the disc after recording.</li> <li><b>HighMAT discs</b> WMA, MP3 or JPEG files only. To play without using the HighMAT function, select "Play as HighMAT" in Other Menu (→ page 27).</li> </ul>

\*A process that allows play on compatible equipment.

•It may not be possible to play the above discs in all cases due to the type of disc or condition of the recording.

## Discs that cannot be played

PAL discs (except DVD-Audio), DVD-ROM, CD-ROM, CDV, CD-G, DVD+R, +RW, DVD-RW, SACD, Divx Video Discs and Photo CD, DVD-RAM that cannot be removed from their cartridge, 2.6-GB and 5.2-GB DVD-RAM, and "Chaoji VCD" available on the market including CVD, DVCD and SVCD that do not conform to IEC62107.

## Audio format of DVDs

This unit automatically recognizes and decodes with these symbols.



## To prevent damage

Do not;

- load more than one disc per tray.
- close the drawer by hand.

## To clean discs

**DVD-A** **DVD-V** **VCD** **CD**

Wipe with a damp cloth and then wipe dry.

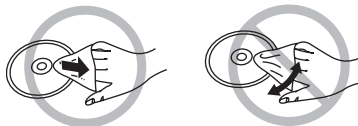

**RAM** **DVD-R**

- Clean with an optional DVD-RAM/PD disc cleaner (LF-K200DCA1, where available).
- Never use cloths or cleaners for CDs etc.

## Handling precautions

- Do not attach labels or stickers to discs (This may cause disc warping, rendering it unusable).
- Do not write on the label side with a ball-point pen or other writing instrument.
- Do not use record cleaning sprays, benzine, thinner, static electricity prevention liquids or any other solvent.
- Do not use scratch-proof protectors or covers.
- Do not use the following discs:
  - Discs with exposed adhesive from removed stickers or labels (rented discs etc).
  - Discs that are badly warped or cracked.
  - Irregularly shaped discs, such as heart shapes.



HighMAT™ and the HighMAT logo are either trademarks or registered trademarks of Microsoft Corporation in the United States and/or other countries.

**HDCD**®, HDCD®, High Definition Compatible Digital® and Pacific Microsonics™ are either registered trademarks or trademarks of Pacific Microsonics, Inc. in the United States and/or other countries.

HDCD system manufactured under license from Pacific Microsonics, Inc. This product is covered by one or more of the following: In the USA : 5,479,168, 5,638,074, 5,640,161, 5,808,574, 5,838,274, 5,854,600, 5,864,311, 5,872,531, and in Australia: 669114, with other patents pending.

# Control reference guide

• If **SHIFT** appears after the button name the function will not work unless you use with [SHIFT] button. Make sure to press [SHIFT] and the button.

## Remote control—common buttons

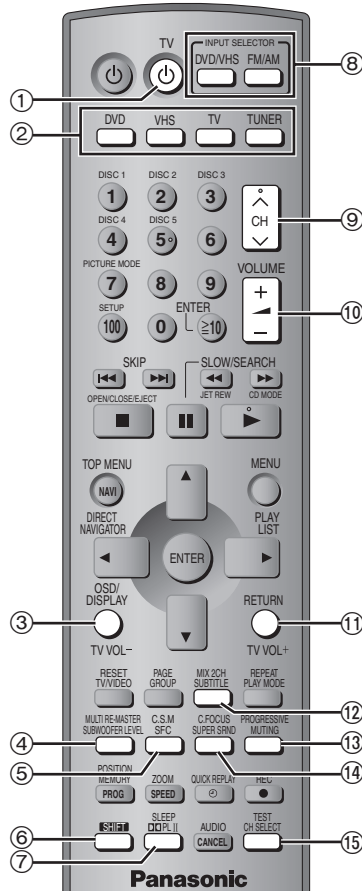

- ① **TV Power button** [TV] ..... 16
- ② **Remote control mode selector button**  
[DVD] [VHS] [TV] [TUNER]  
Changes the remote control mode. The button lights once pressed.  
The selected mode is held in memory until you press another mode selector button.  
The mode selector button lights each time you press an operational control button showing which mode is in use.
- ③ **TV volume down button** [TV VOL-] ..... 16
- ④ **Bass adjust button** [SUBWOOFER LEVEL] ..... 45
- ⑤ **Sound field control button** [SFC] ..... 44
- ⑤ **Custom sound memory button** [C.S.M] **SHIFT** ..... 45
- ⑥ **Shift button** [SHIFT]  
To use the functions labeled in orange, press the button while pressing [SHIFT].
- ⑦ **Dolby Pro Logic II/Dolby Pro Logic button** [DOLBII] ..... 44
- ⑦ **Sleep timer button** [SLEEP] **SHIFT** ..... 46
- ⑧ **Main unit selector button**  
DVD/VHS source button [DVD/VHS]  
Switch the source on the main unit between DVD and VHS.  
Tuner/band button [FM/AM]  
Switch the source on the main unit to tuner and change the band.
- ⑨ **TV channel buttons** [^ v CH] ..... 16
- ⑩ **Volume buttons** [+ - VOLUME] ..... 18  
Volume may be lower when playing DVD-Video than when playing other discs or during television broadcasts. Reduce the volume before playing other sources or returning to the television so volume doesn't increase suddenly.
- ⑪ **TV volume up button** [TV VOL+] ..... 16
- ⑫ **Down-mix button** [MIX 2CH] **SHIFT** ..... 45
- ⑬ **Muting button** [MUTING] ..... 46
- ⑭ **Super surround button** [SUPER SRND] ..... 44
- ⑭ **Center focus button** [C.FOCUS] **SHIFT** ..... 44
- ⑮ **Speaker channel button** [CH SELECT] ..... 45
- ⑮ **Test signal button** [TEST] **SHIFT** ..... 45



## Remote control—DVD operation

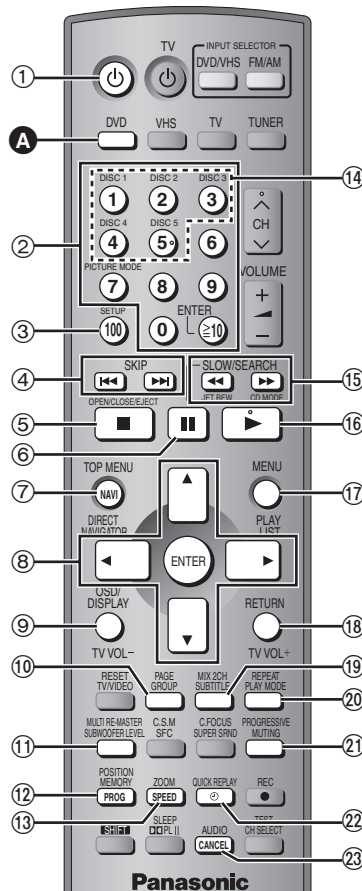

- A** **DVD remote control mode button** [DVD] ..... 17  
Switch the remote control mode to DVD. Make sure you press before doing DVD operations. When in DVD mode, the [DVD] button lights each time you press one of the DVD operation buttons indicated below.
- ① **Power button** [TV] ..... 17  
Press to switch the unit from on to standby mode or vice versa. In standby mode, the unit is still consuming a small amount of power.
- ② **Numbered buttons** [1-9, 0, ≥10/ENTER] ..... 18
- ③ **DVD SETUP menu button** [SETUP] **SHIFT** ..... 17, 28
- ④ **Skip buttons** [SKIP] ..... 18
- ⑤ **Stop button** [■] ..... 18
- ⑤ **Open/close button** [OPEN/CLOSE/EJECT] **SHIFT** ..... 18
- ⑥ **Pause button** [||] ..... 18
- ⑦ **Top menu button** [TOP MENU] ..... 25
- ⑦ **Direct navigator button** [DIRECT NAVIGATOR] ..... 26
- ⑧ **Cursor buttons** [▲ ▼ ◀ ▶] / Enter button [ENTER] ..... 17
- ⑨ **On-screen menu button** [OSD/DISPLAY] ..... 26
- ⑩ **Group button** [GROUP] ..... 19
- ⑩ **Still picture select button** [PAGE] **SHIFT** ..... 21
- ⑪ **Multi re-master button** [MULTI RE-MASTER] **SHIFT** ..... 21
- ⑫ **Position memory button** [POSITION MEMORY] ..... 20
- ⑬ **Zoom button** [ZOOM] ..... 20
- ⑭ **Disc buttons** [DISC1]-[DISC5] **SHIFT** ..... 19
- ⑮ **Slow/search buttons** [SLOW/SEARCH] ..... 18
- ⑮ **CD mode button** [CD MODE] **SHIFT** ..... 21
- ⑯ **Play button** [▶] ..... 18
- ⑰ **Menu button** [MENU] ..... 24
- ⑰ **Play list button** [PLAY LIST] ..... 25
- ⑱ **Return button** [RETURN] ..... 19
- ⑲ **Subtitle button** [SUBTITLE] ..... 20
- ⑲ **Play mode button** [PLAY MODE] ..... 22
- ⑲ **Repeat mode button** [REPEAT] **SHIFT** ..... 23
- ⑲ **Progressive output button** [PROGRESSIVE] **SHIFT** ..... 18
- ⑲ **Quick replay button** [QUICK REPLAY] ..... 21
- ⑲ **Cancel button** [CANCEL] ..... 22
- ⑲ **Soundtrack button** [AUDIO] **SHIFT** ..... 20

● If **SHIFT** appears after the button name the function will not work unless you use with [SHIFT] button. Make sure to press [SHIFT] and the button.

## Remote control—VHS operation

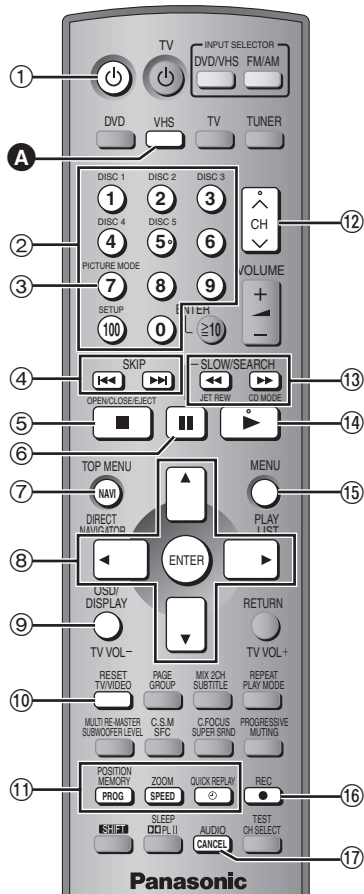

- A VHS remote control mode button [VHS] . . . . .30**  
Switch the remote control mode to VHS. Make sure you press before doing VHS operations. When in VHS mode, the [VHS] button lights each time you press one of the VHS operation buttons indicated below.
- 1 Power button [⏻] . . . . .15**  
Press to switch the unit from on to standby mode or vice versa. In standby mode, the unit is still consuming a small amount of power.
- 2 Numbered buttons [1–9, 100, 0] . . . . .32**
- 3 Picture mode button [PICTURE MODE] **SHIFT** . . . . .31**
- 4 Index search button [◀▶] SKIP . . . . .37**
- 5 Stop button [■] . . . . .30**  
Tape eject button [OPEN/CLOSE/EJECT] **SHIFT** . . . . .30
- 6 Pause button [⏸] . . . . .30**
- 7 Jet navigator button [NAVI] . . . . .36**
- 8 Cursor buttons [▲ ▼ ◀ ▶]/Enter button [ENTER] . . . . .34**
- 9 On-screen display button [OSD/DISPLAY] . . . . .41**
- 10 TV/Video button [TV/VIDEO] . . . . .16**
- 11 Timer recording buttons . . . . .34**  
Timer programming button [PROG]  
Tape speed button [SPEED]  
Timer program standby button [⊙]
- 12 Channel, tracking, and vertical hold buttons [^ v CH] . .31, 32**
- 13 Fast-forward/rewind button [◀▶] SLOW/SEARCH] . . .30**
- 14 Play button [▶] . . . . .30**  
Press and hold for five seconds to start repeat play . . . . .31
- 15 Menu button [MENU] . . . . .38**
- 16 Recording button [● REC] **SHIFT** . . . . .32**
- 17 Cancel button [CANCEL] . . . . .35**  
Audio button [AUDIO] **SHIFT** . . . . .41

## Remote control—TUNER operation

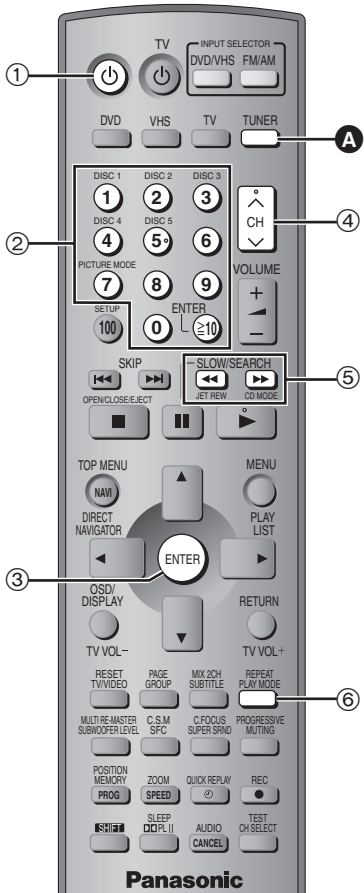

- A TUNER remote control mode button [TUNER] . . . . .42**  
Switch the remote control mode to TUNER. Make sure you press before doing TUNER operations. When in TUNER mode, the [TUNER] button lights each time you press one of the TUNER operation buttons indicated below.
- 1 Power button [⏻] . . . . .42**  
Press to switch the unit from on to standby mode or vice versa. In standby mode, the unit is still consuming a small amount of power.
- 2 Numbered buttons [1–9, 0, ≥10/ENTER] . . . . .42**
- 3 Enter button [ENTER] . . . . .42**
- 4 Channel buttons [^ v CH] . . . . .42**
- 5 Tuning buttons [◀▶] . . . . .42**
- 6 FM mode button [PLAY MODE] . . . . .42**



## Main unit and subwoofer

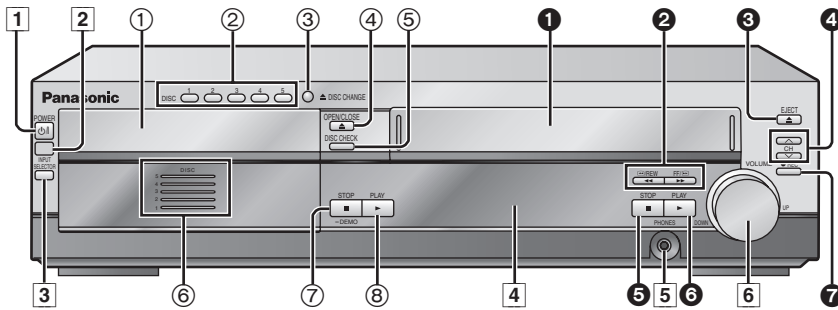

### Common buttons

- 1 Power button [POWER] ..... 15  
Press to switch the unit from on to standby mode or vice versa. In standby mode, the unit is still consuming a small amount of power.
- 2 Remote control signal sensor
- 3 Source selector button [INPUT SELECTOR]  
VHS → DVD/CD → FM → AM
- 4 Display
- 5 Headphone terminal [PHONES] ..... 46
- 6 Volume dial [VOLUME DOWN, UP] ..... 18

### DVD section

- 1 Drawer ..... 18
- 2 Disc buttons [DISC1-5] ..... 18
- 3 Disc change button [DISC CHANGE] ..... 19
- 4 Drawer open/close button [OPEN/CLOSE] ..... 18
- 5 Disc check button [DISC CHECK] ..... 19

- 6 Disc indicators ..... 18
- 7 Stop button [STOP] ..... 18  
Demo button [-DEMO] ..... 18
- 8 Play button [PLAY] ..... 18

### VHS section

- 1 Tape slot ..... 30
- 2 Fast-forward and rewind buttons  
[<< REW] [FF >>] ..... 30
- 3 Tape eject button [EJECT] ..... 30
- 4 Channel buttons [CH] [V CH] ..... 32
- 5 Stop button [STOP] ..... 30
- 6 Play button [PLAY] ..... 30
- 7 Recording button [REC] ..... 32

### Subwoofer

- 1 AC supply indicator [AC IN]  
This indicator lights when the subwoofer is connected to a household AC outlet.

## Main unit display

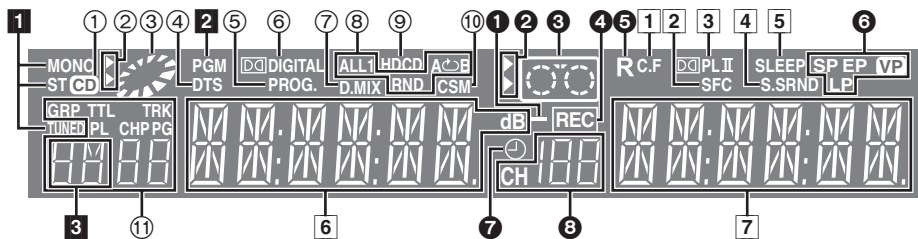

### Common display

- 1 Center Focus indicator ..... 44
- 2 Sound Field Control indicator ..... 44
- 3 Dolby Pro Logic II/Dolby Pro Logic indicator ..... 44
- 4 Super Surround indicator ..... 44
- 5 SLEEP timer indicator ..... 46
- 6 Main display (Orange)  
Disc play elapsed time, program recording end time, volume, TUNER frequency/channel display, various messages, etc.
- 7 Main display (Green)  
Time display, video play/record elapsed time, program recording start time, various messages, etc.

### DVD operation

- 1 CD mode indicator ..... 21  
Lights when CD mode is on.
- 2 DVD selector indicator  
Lights when DVD is selected.
- 3 Operation status of DVD section
  - Lights when a disc is inserted.
  - Displays play status graphically.
- 4 DTS indicator
- 5 Progressive video indicator ..... 18
- 6 Dolby Digital indicator
- 7 Down mix indicator ..... 45
- 8 Play sequence indicator
  - ALL: During all group or all disc random play ..... 22
  - RND: During random play ..... 23
  - 1 RND: During one disc random play ..... 23



- ↻ : During repeat ..... 23
- A ↻ B: During A-B repeat ..... 27
- 9 HDCD indicator ..... 6
- 10 Custom Sound Memory indicator ..... 45
- 11 Group/Play list/Track/Title/Chapter/Program number display

### VHS operation

- 1 VHS playback indicator  
Lights when a video cassette is playing.
- 2 VHS selector indicator  
Lights when the selector is in VHS mode.
- 3 Operation status of VHS section
  - Lights when a video cassette is inserted.
  - Flashes when recording or timer recording is attempted with no video cassette inserted.
  - Displays play status graphically.
- 4 Recording indicator ..... 32
- 5 Repeat playback indicator ..... 31
- 6 Tape speed indicator ..... 32
- 7 Timer program recording indicator ..... 34
- 8 Channel display



### Tuner operation

- 1 Radio broadcast display ..... 42  
MONO: Forced monaural  
ST: Stereo  
TUNED: Receiving radio signal
- 2 Preset indicator ..... 42
- 3 Band display

# Simple setup

## STEP 1 Locating

How you set up your speakers can affect the bass and the sound field. Note the following points.

- Place speakers on flat secure bases.
- Placing speakers too close to floors, walls, and corners can result in excessive bass. Cover walls and windows with thick curtains.
- The front left, right and surround speakers are all the same.

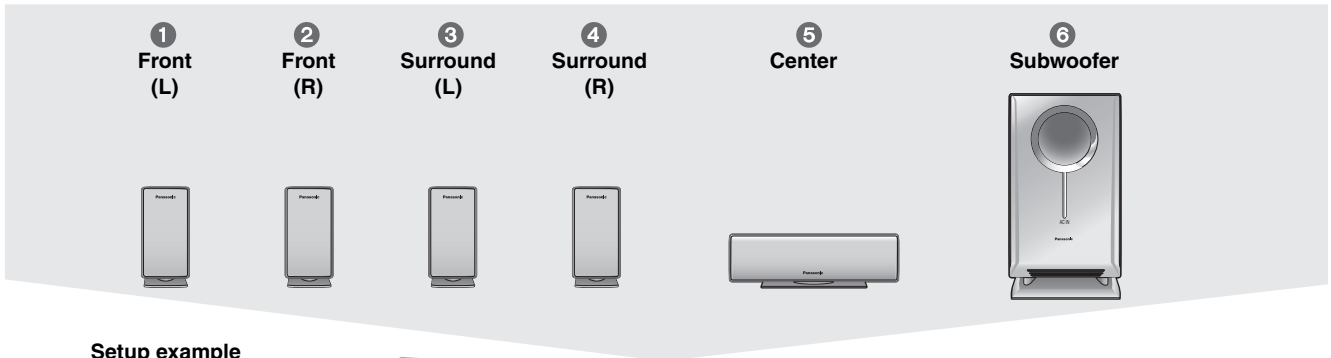

Setup example

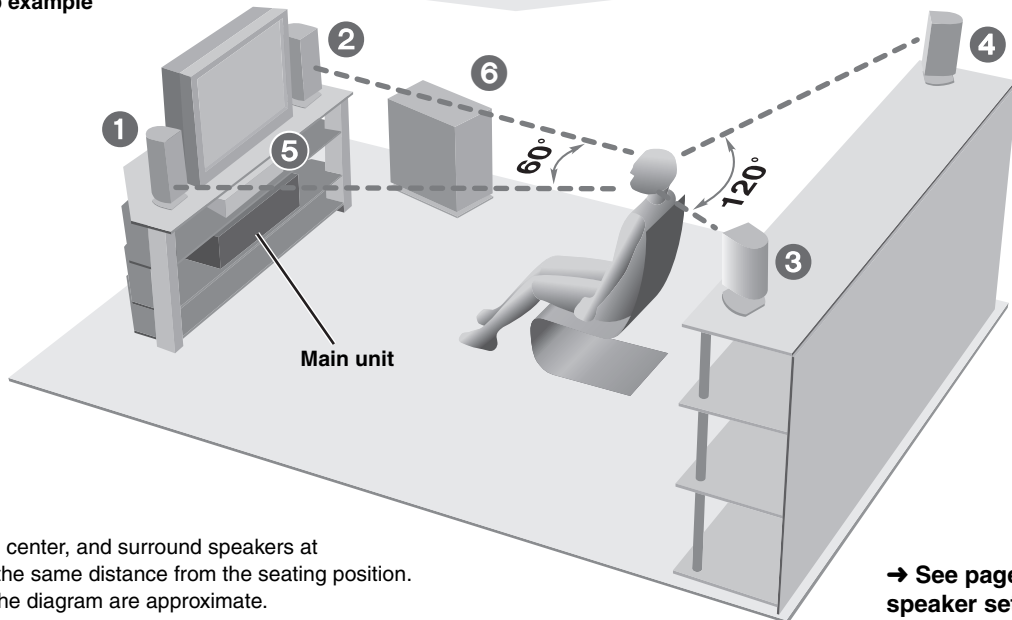

Place the front, center, and surround speakers at approximately the same distance from the seating position. The angles in the diagram are approximate.

→ See page 47 for other speaker setup options.

### • Use only supplied speakers

Using other speakers can damage the unit and sound quality will be negatively affected.

- Set the speakers up on an even surface to prevent them from falling. Take proper precautions to prevent the speakers from falling if you cannot set them up on an even surface.

### Main unit

#### Note

Keep your speakers at least 10 mm ( $\frac{13}{32}$ " ) away from the system for proper ventilation.

### Center speaker

- Vibration caused by the center speaker can disrupt the picture if it is placed directly on the television. Put the center speaker on a rack or shelf.
- To prevent the speakers from falling do not place the speakers directly on top of the television.

### Subwoofer

Place to the right of the television, on the floor or a sturdy shelf so that it won't cause vibration.

Leave 10 cm (4" ) at the rear for ventilation.

### Notes on speaker use

- You can damage your speakers and shorten their useful life if you play sound at high levels over extended periods.
- Reduce the volume in the following cases to avoid damage.
  - When playing distorted sound.
  - When the speakers are receiving howling from a record player, noise from FM broadcasts, or continuous signals from an oscillator, test disc, or electronic instrument.
  - When adjusting the sound quality.
  - When turning the unit on or off.



### Caution

- The main unit and supplied speakers are only to be used as indicated in this setup. Failure to do so may lead to damage to the amplifier and/or the speakers, and may result in the risk of fire. Consult a qualified service person if damage has occurred or if you experience a sudden change in performance.
- Do not attempt to attach these speakers to walls using methods other than those described in this manual.

# STEP 2 Connecting speakers with the subwoofer

Attach the speaker-cable stickers to make connection easier.

### Speaker cables

- 3 × 4-m (13-foot) cables (For Front and Center speakers)
- 2 × 10-m (33-foot) cables (For Surround speakers)

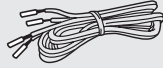

### Sheet of speaker-cable stickers

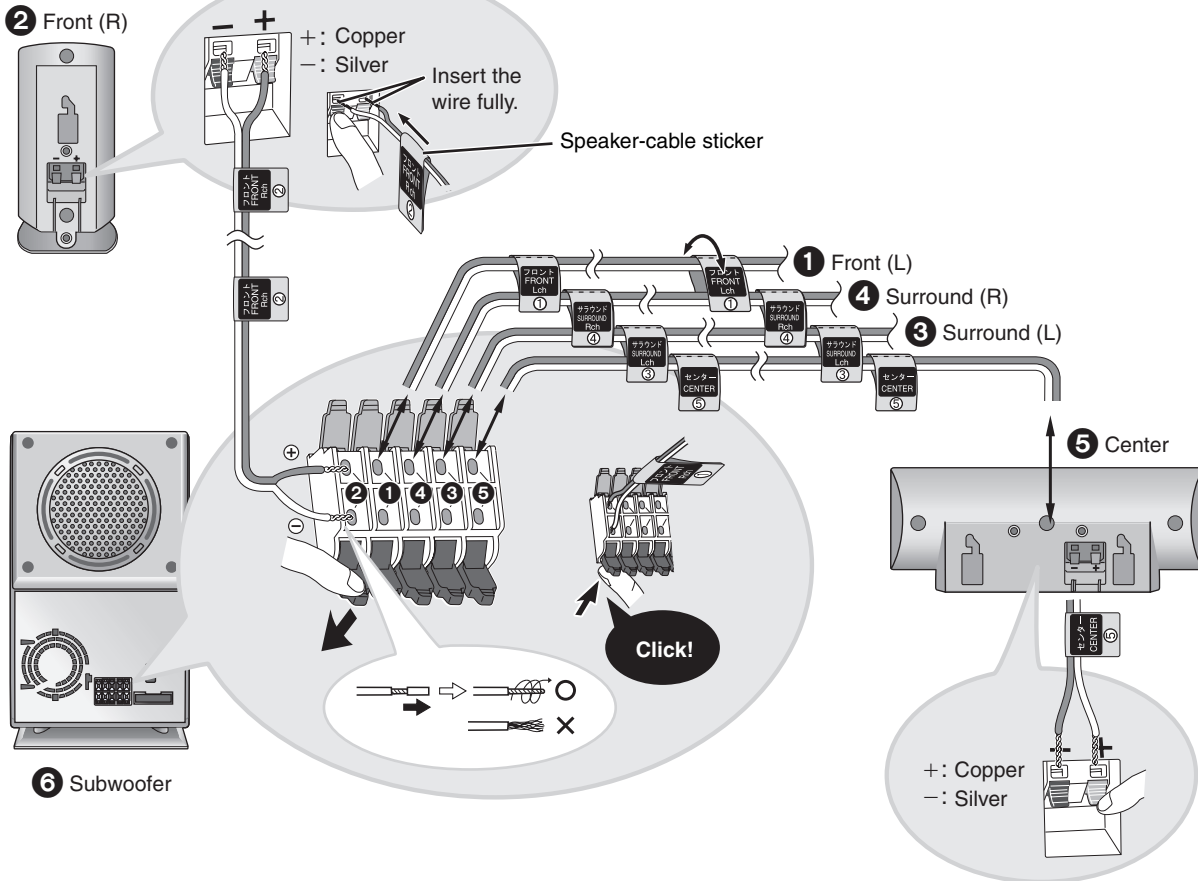

### Note

- Never short-circuit positive (+) and negative (-) speaker wires.
- Be sure to connect only positive (copper) wires to positive (+) terminals and negative (silver) wires to negative (-) terminals. Incorrect connection can damage the speakers.

### Caution

Hold the speakers by the sides. Applying pressure to the front net can damage the speaker.

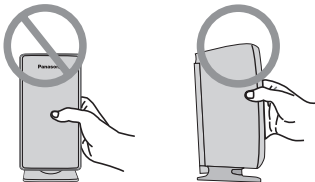

# STEP 3 Television

## Basic connection

75 Ω coaxial cable

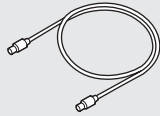

Video cable

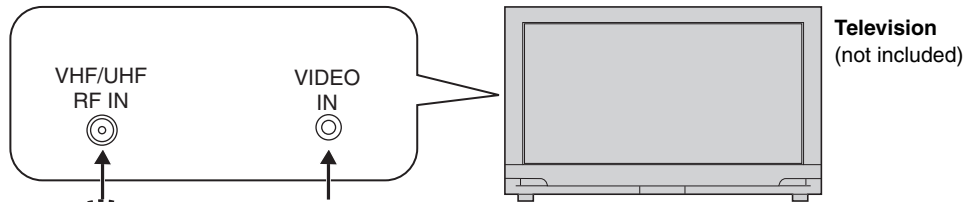

If the connector doesn't match  
→ page 49

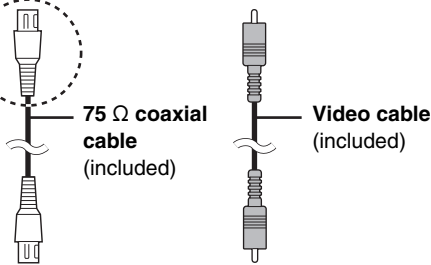

Main unit

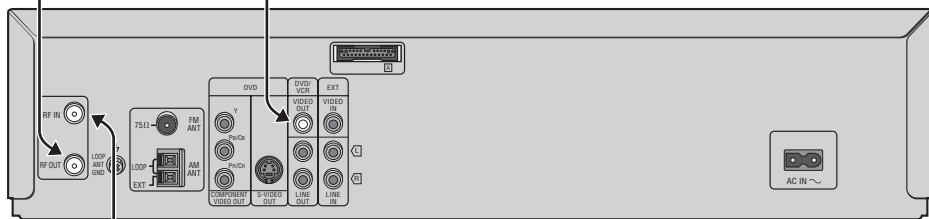

If the connector doesn't match  
→ page 49

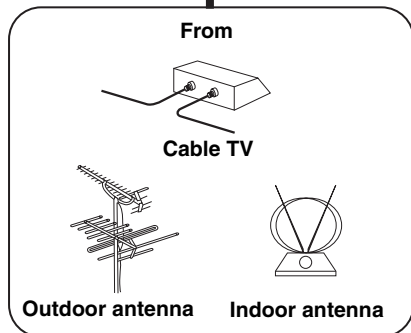
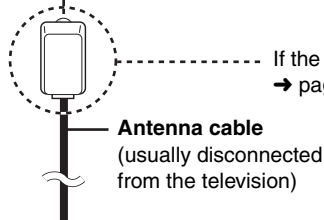

### 75 Ω coaxial cable

This cable carries broadcast signals to the television whether the unit is on or off so you do not need to connect the antenna directly to the television.

It does not carry other signals from this unit, so make sure you connect the television to VIDEO OUT. Contact your dealer if your television does not have the corresponding terminal.

### Connect video cables directly to your television

The video signals on DVDs and videotapes have copyright protection. The video may not be shown correctly if you connect through an A/V selector or other equipment.

### To enjoy cable and satellite television

Connection → page 48

Subscribe to a cable or satellite company.

### If irregular coloring occurs on your television

The supplied speakers are designed to be used close to a television, but the picture may be affected with some televisions and setup combinations.

**If this occurs, turn the television off for about 30 minutes.**

The television's demagnetizing function should correct the problem. If it persists, move the speakers further away from the television.



SETUP

## For better video from DVD

The following connections are for video from the DVD section only. Make sure you have connected the VIDEO OUT terminal with the television to view video from the VHS section (→ page 12).

You may need to change the video-input mode on the television to view video from the VHS and DVD sections. Read your television's operating instructions for details.

### ■ Connecting a television with COMPONENT VIDEO terminals

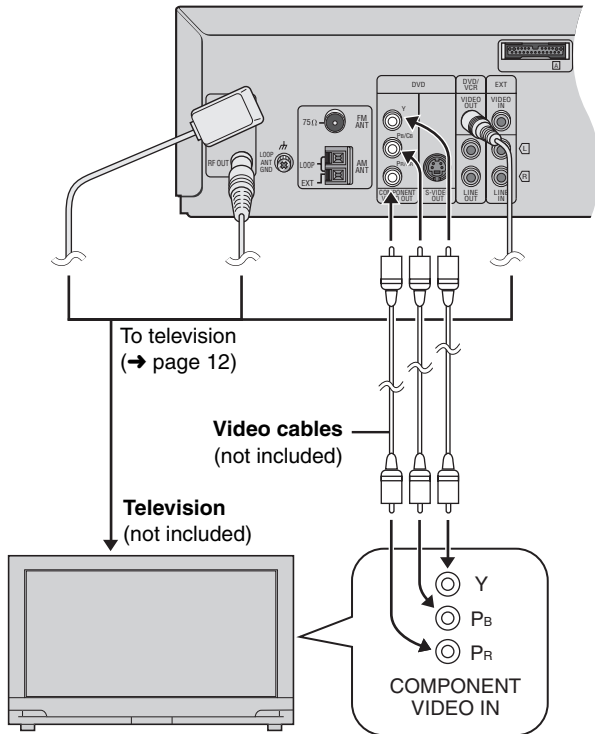

#### COMPONENT VIDEO OUT terminal

These terminals can be used for either interlace or progressive output and provide a purer picture than the S-VIDEO OUT terminal. Connection using these terminals outputs the color difference signals (P<sub>B</sub>/P<sub>R</sub>) and luminance signal (Y) separately in order to achieve high fidelity in reproducing colors.

- The description of the component video input terminals depends on the television or monitor (e.g. Y/P<sub>B</sub>/P<sub>R</sub>, Y/B-Y/R-Y, Y/C<sub>B</sub>/C<sub>R</sub>). Connect to terminals of the same color.
- After making this connection, change the black level for a better picture (→ page 28, Video—Black Level Control).

#### To enjoy progressive video

- Connect to the component video input terminals on a 480P compatible television. (Video will not be displayed correctly if connected to an incompatible television.)
- All televisions manufactured by Panasonic and that have 480P input connectors are compatible. Consult the manufacturer if you have another brand of television.

### ■ Connecting a television with an S-VIDEO IN terminal

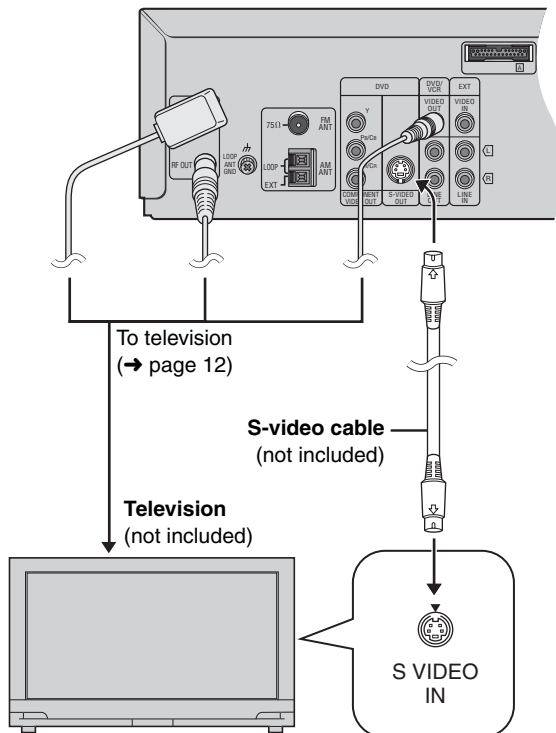

#### S-VIDEO OUT terminal

The S-video terminal achieves a more vivid picture than the VIDEO OUT terminal by separating the chrominance (C) and luminance (Y) signals. (Actual results depend on the television.)

#### Note

Connect to a different terminal group than that you used for the video cable (e.g., "VIDEO 2"). Picture from this unit's VHS will not appear when you use the same group input terminal connections because the S-video terminal input takes precedence.



SETUP

# STEP 4 Radio and system connection

System cable

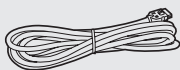

AM loop antenna



FM indoor antenna



2 AC power supply cords

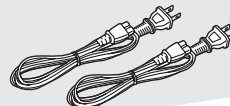

Connect the AC power supply cords after all other connections are complete.

AM loop antenna



Stand the antenna up on its base. Place the antenna where the reception is best. Keep loose antenna cord away from other wires and cords.

FM indoor antenna

Adhesive tape  
Fix the other end of the antenna where reception is best.

Catch up

To disconnect  
Press the catch and pull out.

AC power supply cord

To household AC outlet  
(AC 120 V, 60 Hz)

AC power supply cord

To household AC outlet  
(AC 120 V, 60 Hz)

Subwoofer

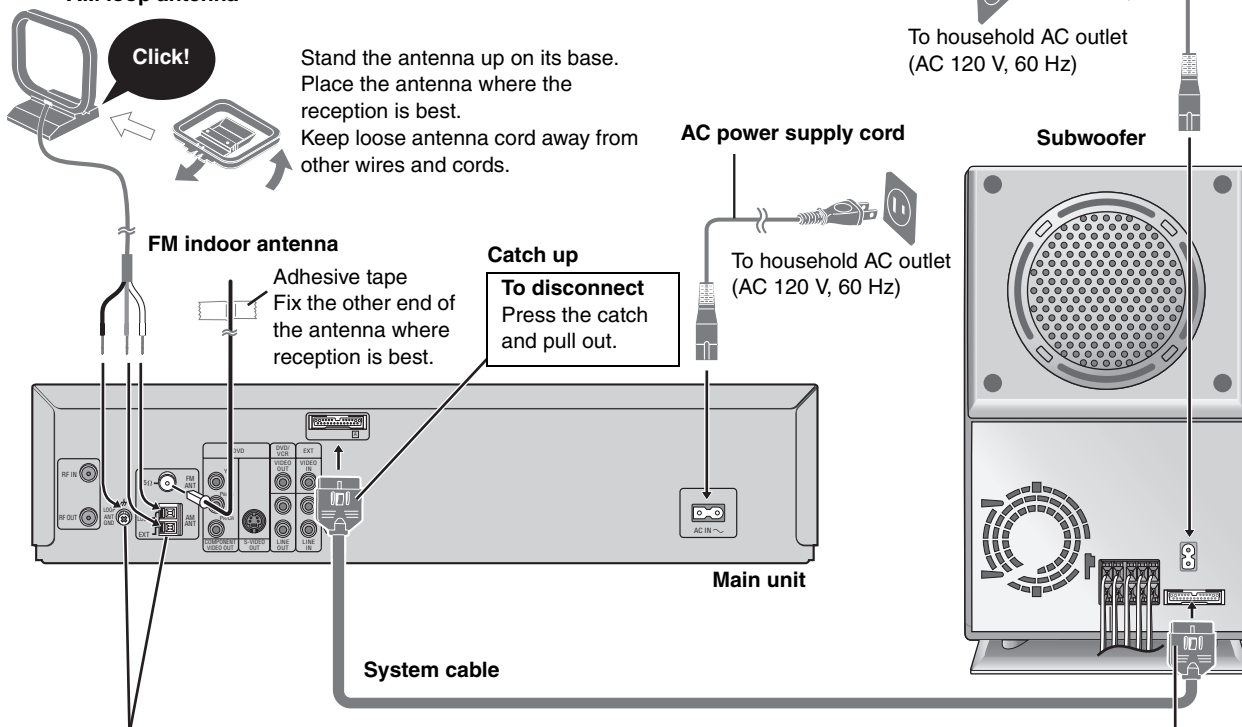

1 Push and insert the antenna cables in as far as possible.

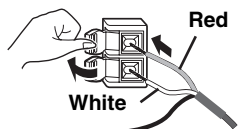

2 Loosen the terminal with a Phillips-head screwdriver.

4 Tighten the terminal screw again.

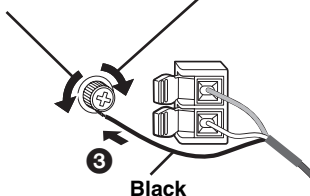

Catch up

To disconnect  
Press the catch and pull out.

## AC power supply cords

Connect both AC power supply cords to enjoy all the features of this system.

## Demo function

When the unit is first plugged in, a demonstration of its functions may be shown on the display. If the demo setting is off, you can show a demonstration by selecting "DEMO ON" in the standby mode.

### Press and hold [–DEMO] on the main unit.

The display changes each time you press and hold the button. DEMO OFF ↔ DEMO ON

While in the standby mode, select "DEMO OFF" to reduce power consumption.

## Conserving power

The main unit consumes a small amount of power, even when it is turned off. The amount of power used depends on the display setting (→ page 40):

BRIGHT: 3.5 W DIM: 3.2 W OFF: 12.9 W

### Audio memory backup

To save power when the unit is not to be used for a long time, unplug it from the household AC outlet.

You will need to reset some memory items after plugging the unit.



SETUP

# STEP 5 Plug-in Auto Tuning

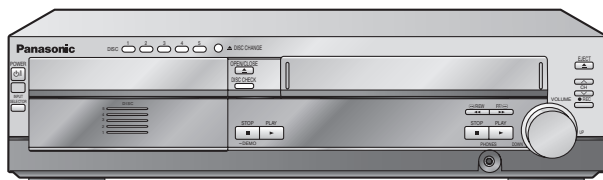

After plugging the unit into your household AC outlet and pressing [⏻] to turn the unit on for the first time, the unit automatically tunes in all the channels it can receive and sets the clock.

The unit determines the type of transmission, TV or CATV, as follows:

TV: when there are less than 5 CATV channels.

CATV: when there are 5 or more CATV channels.

### Preparation

- Confirm that the antenna is connected correctly.
- Turn on the television and select the video input for the VHS.
- Press [VHS] to put the remote control in VHS mode.

### Press [⏻] to turn on the unit.

Plug-in Auto Tuning starts and the unit puts the stations it can receive into channels (→ page 39, Channel range).

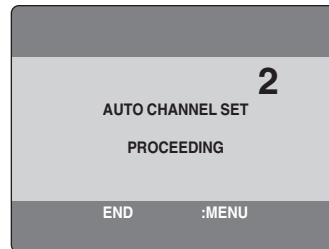

The unit starts auto clock setting when finished, then displays the time.

### Note

If auto tuning stops partway (by changing the source, turning the unit off, or due to a power failure.)

- 1 Disconnect the AC power supply cord on the main unit and then reconnect it.
- 2 Turn on the main unit.

### To cancel partway

Press [MENU].

### ■ To start Plug-in Auto Tuning again (after relocation, for example)

#### Preparation

- Press [⏻] to turn on the unit.
- Make sure there is no video cassette tape loaded in the unit.
- Press [DVD/VHS] to select "VHS" as the source.

- 1 Press and hold [v CH] and [^ CH] on the main unit simultaneously for 3 seconds until the channel changes to "2".



- 2 Disconnect the AC power supply cord on the main unit and then reconnect it.
- 3 Turn on the main unit. Plug-in Auto Tuning restarts.

**Antenna system and channel captions all revert to the default values when you perform the procedure above. Reset the timer recording settings. (If necessary reset the clock first. → page 38, CLOCK SET)**

### ■ To set the channels manually (→ page 39).

### ■ If the unit couldn't set the clock automatically

The MANUAL CLOCK SET screen appears. Set the time manually (→ page 38).



# STEP 6 Operating the television



## ■ TV maker setting

You can control the television by entering the remote control code.

**1 Refer the chart below for the code for your television.**

**2 Aiming the remote control at the television**



**While pressing and holding [TV] (  ), press the numbered buttons to enter the code number.**

- Example: To select 01, press [0] → [1].
- The remote control outputs the on/off signal. If the code is correct, the equipment turns on or off. If it doesn't, try entering another code.

### Note

- If your television brand is not listed or if the code listed for your television does not allow control of your television, this remote control is not compatible with your television.
- Reenter the codes after you change the batteries.

## ■ TV operation

Operation	Buttons
Power on/standby	[  TV]
Remote control TV mode	[TV] ● Switch the remote control mode to TV. Press before doing TV operations. When in TV mode, the [TV] button lights each time you press an operation button.
TV/Video switch	[TV/VIDEO]
Selecting channels	[  CH], [  CH] or numbered buttons [1-9, 100, 0, $\geq 10$ /ENTER]. ● [ $\geq 10$ /ENTER] is used to confirm channel selection on some televisions manufactured by other companies.
Adjusting volume	[TV VOL-] [TV VOL+]

Manufacturer	Code No.	Manufacturer	Code No.
Panasonic	01, 02	PHILIPS	06
FISHER	14	PIONEER	02, 10, 19
G.E.	02, 03, 07, 09	QUASAR	02
GOLD STAR	07, 15	RCA	03, 07, 09, 13, 23, 24, 25
HITACHI	05, 07	SANYO	14
JVC	12	SHARP	08, 21
LXI	03, 06, 07, 10, 14, 15	SONY	04
MAGNAVOX	06, 07, 11, 15, 22	SYLVANIA	06, 07, 15
MITSUBISHI	07, 15, 16, 21	SYMPHONIC	17
NEC	07, 15	TOSHIBA	10, 21
PHILCO	06, 07	ZENITH	18, 20



# STEP 7 DVD QUICK SETUP





Turn on the television and select the video input for the DVD.

The **QUICK SETUP** screen assists you to make necessary settings such as:

- Menu Language (→ page 29)
- TV Type (→ page 28)
- TV Aspect (→ page 28)





- 

Press to put the remote control in DVD mode.
- 

Turn on the unit.
- 

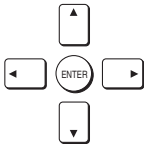
Select "DVD/CD".
- 

Shows QUICK SETUP screen.
- 

Follow the messages and make the settings.
- 

Press to finish QUICK SETUP.
- 

Press to exit.

**To change these settings later**

Select "QUICK SETUP" in "Others" tab (→ page 29).

Turn on the television and select the appropriate video input for the DVD.

- Put the remote control in DVD mode.**
- Turn on the unit.**
- Select "DVD/CD".**
- Select the disc tray.**
- Open the disc tray and load the disc.**
  - Load double-sided discs so the label for the side you want to play is facing up.
- Close the disc tray.**
  - A disc indicator lights green to show the tray is in the play position.
  - To load discs on the other trays, repeat steps 4 and 6.
- Start play.**
- Adjust the volume.**

--dB 0dB  
(Minimum) (Maximum)

**Progressive video**

**SHIFT** + **PROG.**

**PROGRESSIVE MUTING**

**Stop**

**OPEN/CLOSE/EJECT**

The position is memorized when "⏏" flashes on the display.

- Press **[▶]** (PLAY) to resume.
- DVD-V** To review the previous chapters (→ page 20, Position memory)
- Press **[■]** to clear the position.

**Pause**

Press **[▶]** (PLAY) to start play.

**Skip**

**SKIP**

**(Group skip)** **WMA** **MP3** **JPEG**

Select

Register

**Search** (during play)

**Slow-motion** (during pause)

**SLOW/SEARCH**

- Up to 5 steps
- Press **[▶]** (PLAY) to start play.
- VCD** Slow motion, forward direction only

**Frame-by-frame** (during pause)

**VCD** forward direction only

**On-screen item select**

Select

Register

**Enter number**

**RAM** **DVD-A** **DVD-V** **VCD** **CD**

e.g. To select 12:  
[≥10] → [1] → [2]

**VCD** with playback control  
While stopped, press the numbered buttons.

**WMA** **MP3** **JPEG**

e.g. To select 123:  
[1] → [2] → [3] → [ENTER]

- Press **[CANCEL]** to cancel the number(s).

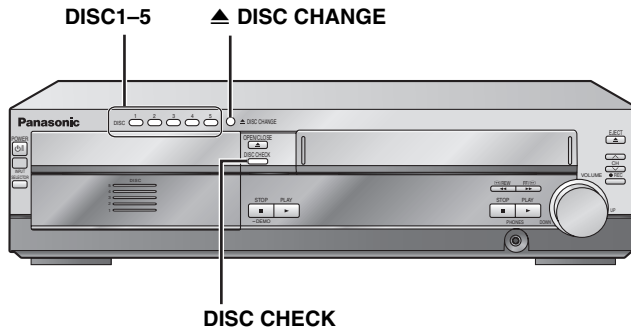

**Disc menu**

**TOP MENU** **DVD-A** **DVD-V**  
Shows a disc top menu

**NAVI**

**MENU** **DVD-V**  
Shows a disc menu

**RETURN** **VCD**  
Shows a disc menu

**Return to previous screen**

**RETURN**

**Information screen**

**MIX 2CH SUBTITLE** **WMA** **MP3** **JPEG**  
Turns the information screen on/off

**Starting play from a selected group**

**DVD-A** **WMA** **MP3** **JPEG**  
A folder on WMA/MP3 and JPEG discs is treated as a "Group".

**PAGE GROUP** → **ENTER**

Select

Register

**Selecting the disc directly**

**SHIFT**

+

DISC 1 2 3  
DISC 4 5

• You can select the disc with [DISC1-5] on the main unit.

**Checking the disc trays**

**(Main unit)**  
**DISC CHECK**

All discs except the disc in play open without interrupting play. While stopped, all trays will open.

- Press [DISC CHECK] again to close the trays.
- Do not pull out the trays, remove, or insert discs during the disc check.

**Changing the discs during play**

**(Main unit)**  
**▲ DISC CHANGE**

↓

DISC 1 2 3 4 5

You can change the other discs without interrupting play.

- After selecting the disc tray, press [▲ DISC CHANGE] to close the tray.

**Note**

Discs continue to rotate while menus are displayed. Press [■] when you finish to preserve the unit's motor and your television screen.

If you are experiencing problems, refer to troubleshooting (→ pages 50-52).



**Position memory**

Memorizes the position to resume play.



**Zoom**

Expands the letterbox picture to fit the screen.



**Subtitle**

Changes the subtitle language.



**Audio**

Changes the soundtrack.

See below for details.



DVD

**Position memory**

(Only when the elapsed play time can be displayed)  
**JPEG**: Works with all JPEG content  
 This position is memorized even after turning off the unit, changing the source or moving the disc out of the play position.

Press **[POSITION MEMORY]**.

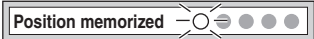

- Up to 5 discs.
- When the sixth disc is memorized, the earliest position is replaced.
- You cannot recall the position in CD Mode (→ page 21).

When the unit is turned on, "DVD/CD" is reselected or the disc comes to the play position,

Press **[▶] (PLAY)** to start play from that position.

To review the previous chapters **DVD-V**  
 Press **[▶] (PLAY)** while the following message is displayed.



Do not press **[▶] (PLAY)** if you want to cancel review.

**Zoom**

**RAM DVD-V VCD**

Press **[ZOOM]** several times to select the preset aspect ratio or "Auto". (Just Fit Zoom)

Fine adjustments (Manual Zoom)

Press **[◀▶]**.  
 –from ×1.00 to ×1.60 (in 0.01 units)  
 –from ×1.60 to ×2.00 (in 0.02 units)



**Subtitle**

**DVD-V** (with multiple subtitles) **VCD** (SVCD only)  
**RAM** (On/Off only)

Press **[SUBTITLE]** several times to select the subtitle language.

To clear/display the subtitles  
 Press **[◀▶]** to select "On" or "Off".



**Audio**

**DVD-A DVD-V** (with multiple soundtracks) **RAM VCD**

Press **[SHIFT] + [AUDIO]** several times to select the soundtrack.



**RAM VCD**  
 You can use this button to select "L", "R" or "LR".

**DVD-V** (Karaoke discs)  
 Press **[◀▶]** to select "On" or "Off" of vocals.  
 Read the discs instructions for details.

**Signal type/data**

LPCM/PPCM/□□ Digital/DTS/MPEG: Signal type  
 kHz (Sampling frequency)/bit/ch (Number of channels)

Example:

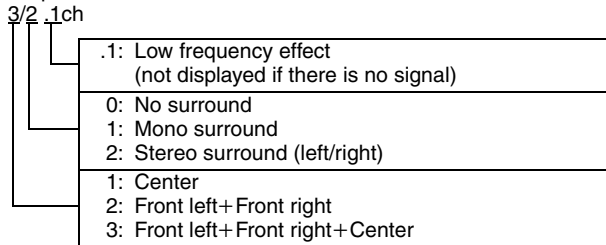



**SHIFT** + **MULTI RE-MASTER SUBWOOFER LEVEL**  
**Multi Re-master**  
 Enjoys more natural sound.

**SHIFT** + **PAGE GROUP**  
**Page skip**  
 Selects still pictures.

**SHIFT** + **CD MODE**  
**Sequential play (CD Mode)**  
 Plays discs in succession.

**QUICK REPLAY**  
**Quick replay**  
 Replays a scene.

See below for details.



DVD

## Multi Re-master

**RAM** **DVD-V** (Discs recorded with 48 kHz only)  
**DVD-A** (Discs recorded with 44.1 kHz and 48 kHz only)  
**VCD** **CD**

- During 2ch output of these discs, this feature gives you a more natural sound by adding the higher frequency signals not recorded on the disc.
- During multi-channel output of these discs, this feature reproduces the frequencies lost during recording to give you a sound closer to the original.

**WMA** **MP3** (Disc recording is other than 8 kHz, 16 kHz, 32 kHz)  
 This feature reproduces the higher frequencies lost during recording to give you a sound closer to the original.

Press **[SHIFT]** + **[MULTI RE-MASTER]** to select "1" "2" or "3".



Setting	<b>DVD-A</b> <b>DVD-V</b> <b>CD</b> (LPCM/PPCM)	Other discs
	Type of music	Effect level
1	High tempo (e.g., pops and rock)	Light
2	Various tempos (e.g., jazz)	Medium
3	Low tempo (e.g., classical)	Strong
Off	Off	Off

## Page skip

**DVD-A**  
 During play or while paused  
 Press **[SHIFT]** + **[PAGE]**.  
 The page changes each time you do this.

## Sequential play (CD Mode)

**VCD** **CD** **WMA** **MP3**

While stopped

Press **[SHIFT]** + **[CD MODE]** to play all loaded discs (except for DVDs and JPEG files).



- HighMAT menus and Video CD playback control are disabled.
- You cannot change the mode during program or random play (→ page 22).
- CD Mode turns off when you switch the unit to standby.

## Quick replay

Except **JPEG**  
 (Only when the elapsed play time can be displayed)  
 Press **[QUICK REPLAY]** to skip back a few seconds.



All group or program play

See below for details.



DVD

## All group/Program/Random play

While stopped, press [PLAY MODE].

Each time you press the button:

**DVD-A DVD-V WMA MP3**

All group (**DVD-A**) → Program → Random → off (Normal play)

**VCD CD** (There is no on-screen display.)  
 (PGM) → 1-DISC (1 RND) → A-DISC (ALL RND)  
 off (Normal play)

### To exit

Press [PLAY MODE] several times while stopped.

- Disable HighMAT disc play to use random and program play. Select "Play as Data Disc" in Other Menu (→ page 27).

### All group play

**DVD-A**

Press [▶] (PLAY).

### Program play (up to 24 items)

**VCD CD**

You can program all the items on discs.

**DVD-A DVD-V WMA MP3**

You can program all the items on a disc in the play position.

**1** **VCD CD**

Press [SHIFT]+([DISC1]–[DISC5]).

**2** Press the numbered buttons to select the items (**WMA MP3** then press [ENTER]).

e.g. **CD**



Disc No. Track No. Program No.

- To select a 2-digit number

e.g. 23: [≥10] → [2] → [3]

**WMA MP3** [2] → [3] → [ENTER]

- Repeat this step to program other items.

- **VCD CD**

Step 1 is unnecessary when programming tracks on the same disc.

- **DVD-A DVD-V WMA MP3**

To select an item using the cursor buttons

Press [ENTER] and [▲ ▼] to select an item, then press [ENTER] again to register.

All the items in the selected disc, title or group are selected when you select "ALL".

## 3 Press [▶] (PLAY).

### To add or change the program

**VCD CD** (Add only)

Repeat steps 1 and 2.

**DVD-A DVD-V WMA MP3**

Press [▲ ▼] to select an item, then repeat step 2.

### To clear an item

**VCD CD**

Press [CANCEL].

**DVD-A DVD-V WMA MP3**

1 Press [▲ ▼] to select an item.

2 Press [CANCEL] (or press [▲ ▼ ◀ ▶] to select "Clear" and press [ENTER]).

### To clear the whole program

**VCD CD**

Press [■] so "CLEAR" is displayed.

**DVD-A DVD-V WMA MP3**

Press [▲ ▼ ◀ ▶] to select "Clear all" and press [ENTER].

### Note

- **DVD-V WMA MP3**

Times are not displayed while programming.

- **VCD CD**

Items the unit cannot find can be programmed but are canceled during play. This is also the case if you program DVD-RAM, DVD-Audio, DVD-Video, WMA, MP3 and JPEG.

- The program is cleared when you switch the unit to standby, select another source, exit the program mode by pressing [PLAY MODE] or move the disc out of the play position.

**VCD CD** The program is retained in memory.



Random play



Repeat play

See below for details.



DVD

**Random play**

VCD CD

1-DISC (1 RND): You can play all the items on a disc in the play position in random order.

A-DISC (ALL RND): You can play all the items on all the discs in random order.

DVD-A DVD-V WMA MP3

You can play selected item(s) on a disc in the play position in random order.

**1 Press the numbered buttons to select a title or a group.**

e.g. DVD-V

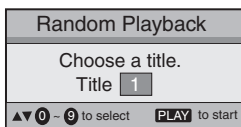

DVD-A

• To enter all groups, press [◀ ▶] to select "All" and press [ENTER].

• To deselect a group, press the numbered buttons corresponding to the group you want to clear.

**2 Press [▶] (PLAY).**

**Repeat play**

(Only when the elapsed play time can be displayed)  
 [JPEG]: Works with all JPEG content.)

During play

**Press [SHIFT]+[REPEAT] several times to select an item to be repeated.**



RAM

PG REPEAT → ALL REPEAT (Entire disc) → REPEAT OFF

• During play list play  
 SCENE REPEAT → PL REPEAT → REPEAT OFF

DVD-A

TRACK REPEAT → GROUP REPEAT\* → REPEAT OFF

DVD-V

CHAPTER REPEAT → TITLE REPEAT\* → REPEAT OFF

VCD CD

(There is no on-screen display.)

TRACK REPEAT → ALL REPEAT (Entire disc) → REPEAT OFF

WMA MP3

(There is no on-screen display.)

CONTENT REPEAT → GROUP REPEAT\* → REPEAT OFF

JPEG

GROUP REPEAT → REPEAT OFF

\* During all group (DVD-A), program and random play "ALL REPEAT" is displayed.



Playing data discs



Playing HighMAT discs



Playing the programs



Playing a play list

See below and the following page for details.



Playing data discs

WMA MP3 JPEG

You can play JPEG files on DVD-RAM or play HighMAT discs without using the HighMAT function (→ page 27, "Play as Data Disc" in Other Menu).

■ Using playback menus (except JPEG files on DVD-RAM)

While the menu is displayed

Press [▲ ▼] to select "All", "Audio", or "Picture" and press [ENTER].

• To display/exit the screen

Press [TOP MENU].

■ Using navigation menus

1 Press [MENU].

2 Press [▲ ▼ ◀ ▶] to select the group or audio/picture content and press [ENTER].

Using the submenu WMA MP3 JPEG

1 While the menu is displayed

Press [OSD/DISPLAY].

Multi	Groups and contents
List	Contents only
Tree	Groups only
Thumbnail	Thumbnail images JPEG
Next group	To go to next groups WMA MP3
Previous group	To go to previous groups WMA MP3
All	WMA/MP3 and JPEG files
Audio	WMA/MP3 files only
Picture	JPEG files only
Help display	To switch between guide messages and the elapsed play time indicator
Find	To search by content or group title (→ see below)

2 Press [▲ ▼] to select the submenu and press [ENTER].

■ Searching by content or group title

WMA MP3 JPEG

Place the cursor on the group title to search a group, or place the cursor on the content title to search contents.

1 Select "Find" (→ see above).



2 Press [▲ ▼] to select a character and press [ENTER].

- Repeat to enter another characters.
- Lower case is also searched.
- Press [◀ ▶] to skip between A, E, I, O and U.
- Press [◀] to erase a character.
- Erase the asterisk (\*) to search for the titles starting with that character.

3 Press [▶] to select "Find" and press [ENTER].

The search result screen appears.

4 Press [▲ ▼] to select the content or group and press [ENTER].

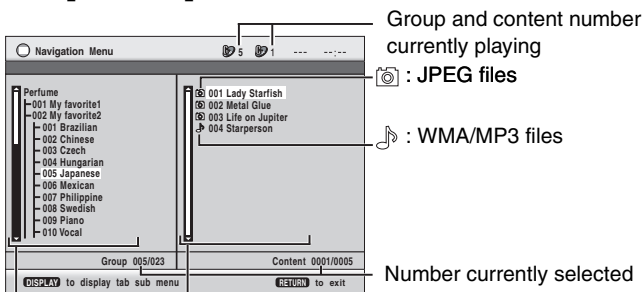

Group Audio/picture contents

• To enjoy listening to WMA/MP3 contents while showing a JPEG image on the screen

Select a JPEG file first, and then select tracks. (The opposite order is not effective.)

• To exit the screen

Press [MENU].

To use the contents screen to find a track

CD (CD text only)

While the menu is displayed

Press [▲ ▼] to move through the tracks and press [ENTER].

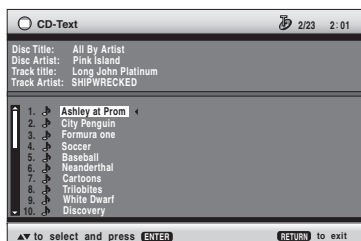



## Playing HighMAT discs

WMA MP3 JPEG

1 Press [TOP MENU].

2 While the menu is displayed  
Select the item following the on-screen instructions.

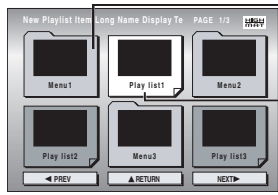

Menu: Takes you to the next menu which shows play lists or another menu

Play list: play starts

•To change the menu background

Press [OSD/DISPLAY].

The background changes to the one recorded on the disc.

•To display/exit the screen

Press [TOP MENU].

■ Selecting from the list

1 Press [MENU].

2 Press [◀] then  
[▲ ▼] to switch  
among Playlist,  
Group and  
Content lists.

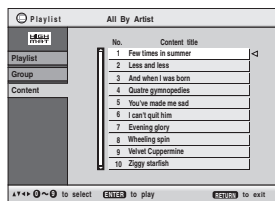

3 Press [▶] then [▲ ▼] to select an item and press [ENTER].

•To exit the screen

Press [MENU].

## Playing the programs

RAM

1 Press [DIRECT NAVIGATOR].

•Titles appear only if you have entered them.

•You cannot change program and disc titles.

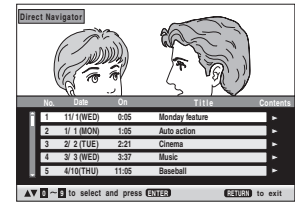

2 Press [▲ ▼] or the numbered buttons to select the program.

•To select a 2-digit number

e.g. 23: [≧10] → [2] → [3]

•Press [▶] to show the contents of the program.

## Playing a play list

RAM

(Only when the disc contains a play list)

1 Press [PLAY LIST].

2 Press [▲ ▼] or the numbered buttons to select the play list.

•To select a 2-digit number

e.g. 23: [≧10] → [2] → [3]



3 Press [ENTER].



DVD

### Tips for making WMA/MP3 and JPEG discs (For CD-R/CD-RW)

- Discs must conform to ISO9660 level 1 or 2 (except for extended formats).
- This unit is compatible with multi-session but if there are a lot of sessions it takes more time for play to start. Keep the number of sessions to a minimum to avoid this.

### Naming folders and files

At the time of recording, prefix folder and file names with 3-digit numbers in the order you want to play them (this may not work at times).

Files must have the extension:

“.WMA” or “.wma”

“.MP3” or “.mp3”

“.JPG”, “.jpg”, “.JPEG” or “.jpeg”

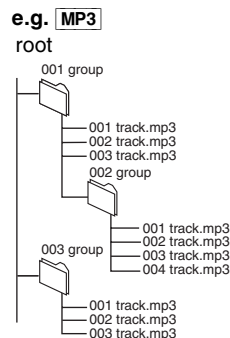

WMA

- You cannot play WMA files that are copy protected.

MP3

- This unit is not compatible with ID3 tags.
- Compatible sampling rate: 8, 11.02, 12, 16, 22.05, 24, 32, 44.1 and 48 kHz.

JPEG

- To view JPEG files on this unit:

–Take them on a digital camera that meets the DCF Standard (Design rule for Camera File system) Version 1.0. Some digital cameras have functions that are not supported by the DCF Standard Version 1.0 like automatic picture rotation which may render a picture unviewable.

–Do not alter the files in any way or save them under a different name.



- This unit cannot display moving pictures, MOTION JPEG and other such formats, still pictures other than JPEG (e.g. TIFF) or play associated sound.

Windows Media, and the Windows logo are trademarks, or registered trademarks of Microsoft Corporation in the United States and/or other countries.

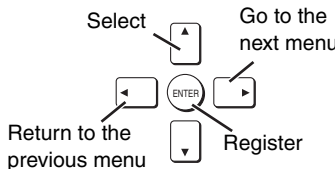
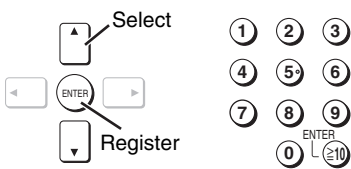

WMA is a compression format developed by Microsoft Corporation. It achieves the same sound quality as MP3 with a file size that is smaller than that of MP3.

MPEG Layer-3 audio decoding technology licensed from Fraunhofer IIS and Thomson multimedia.

<p><b>1</b></p>  <p>Press once. (When pressed twice, the elapsed play time indicator appears. → below)</p>	<p><b>2</b></p>  <p>Select the menu.</p>	<p><b>3</b></p>  <p>Make the settings.</p>	<p><b>4</b></p>  <p>Press to exit.</p>
---	---	--	---

Items shown differ depending on the type of software.

**Main menus**

<b>Program Group</b>	<b>To start from a specific item</b>
<b>Title</b>	
<b>Chapter</b>	
<b>Track</b>	
<b>Playlist</b>	
<b>Content</b>	
<b>Time</b>	<p><b>To skip incrementally or decrementally (Time Slip)</b></p> <p>1 Press [ENTER] twice to show Time Slip indicator.</p> <p>2 Press [▲ ▼] to enter the time and press [ENTER].</p> <p>● Press and hold [▲ ▼] to alter faster.</p> <p><b>To start from a specific time (Time Search)</b></p> <p><b>To change remaining/elapsed time display</b></p>
<b>Audio</b>	<p>(→ page 20)</p> <p><b>To displays the current bitrate or sampling frequency</b></p>

<b>Still Picture</b>	<b>To switch still picture</b>
<b>Thumbnail</b>	<b>To show thumbnail images</b>
<b>Subtitle</b>	(→ page 20)
<b>Marker(VR)</b>	<b>To recall a marker recorded on DVD-Video recorders</b>
<b>Angle</b>	(with multiple angles) <b>To select the angle</b>
<b>Rotate Picture</b>	<b>To advance pictures</b> <b>To rotate pictures</b>
<b>Slideshow</b>	<b>To turn on/off slideshow</b> <b>To change the slideshow timing (0–30 sec)</b>



DVD

**■ Elapsed play time indicator**  
(except **JPEG**)

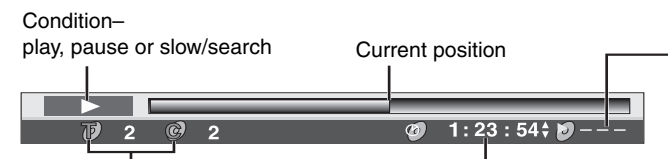

Condition—play, pause or slow/search

Current position

Play mode  
 ---: Normal play  
 PGM: Program play  
 RND: Random play  
 ALL: All group play **DVD-A**  
 PBC: Playback control is on **VCD**

Current playback item

Press [▲ ▼] to select the elapsed play time or the remaining time.

## Other settings

Play Speed	<b>RAM DVD-V</b> To change play speed – from $\times 0.6$ to $\times 1.4$ (in 0.1 units)
	<ul style="list-style-type: none"> <li>After you change the speed – Sampling frequency of 96 kHz is converted to 48 kHz.</li> </ul>

## ■ Play Menu

(Only when the elapsed play time can be displayed)

**JPEG**: Works with all JPEG content.)

Repeat	(→ page 21)
A-B Repeat	Except <b>JPEG</b> <b>RAM</b> (still picture part) To repeat a specified section Press [ENTER] at the starting and ending points. Press [ENTER] again to cancel.
Marker	<p>To mark up to 5 positions to play again Press [ENTER] (The unit is now ready to accept markers.) To mark a position: [ENTER] (at the desired point)</p> <p>To mark another position: [◀▶] → [ENTER] To recall a marker: [◀▶] → [ENTER] To erase a marker: [◀▶] → [CANCEL]</p> <ul style="list-style-type: none"> <li>This feature doesn't work during program and random play.</li> </ul>

## ■ Picture Menu

Picture Mode	<p><b>Normal</b></p> <p><b>Cinema1:</b> Mellows images and enhances detail in dark scenes.</p> <p><b>Cinema2:</b> Sharpens images and enhances detail in dark scenes.</p> <p><b>Animation Dynamic</b></p> <p>User (Press [ENTER] to select "Picture Adjustment") (→ below)</p>
	<p><b>Picture Adjustment</b></p> <p><b>Contrast Brightness Sharpness Color Gamma</b> (Adjusts the brightness of dark parts.)</p> <p><b>Depth Enhancer</b> Reduce the rough noise in the background to give a greater feeling of depth.</p> <ul style="list-style-type: none"> <li>This does not work while using Cinema 1 or 2 (→ above).</li> </ul> <p><b>Block NR</b> Smooths block noise.</p> <p><b>Mosquito NR</b> Reduces the smudging that appears around contrasting sections of the picture.</p> <p><b>3D-NR/Dot NR</b> Reduces overall noise/Reduces the dot noise that occurs at the borders between colors.</p>
Video Output Mode	480I (Interlace) ↔ 480P (Progressive)
Transfer Mode	<p>If you have chosen "480P" (→ above), select the method of conversion for progressive output to suit the type of material.</p> <p><b>Auto1</b> (normal): For viewing film material</p> <p><b>Auto2:</b> For viewing film material (the same as Auto 1, but able to convert 30-frame-per-second progressive video)</p> <p><b>Video:</b> For video material</p>

## ■ Audio Menu

Dolby Pro Logic II	(→ page 44)
Dialogue Enhancer	<p>To make the dialogue in movies easier to hear</p> <p><b>DVD-V</b> (Dolby Digital, DTS, MPEG, 3-channel or over, with the dialogue recorded in the center channel)</p> <p>On ↔ Off</p>
Multi Re-master	(→ page 21)

## ■ Display Menu

Information	On ↔ Off ( <b>JPEG</b> : Off, Date, Details)
Subtitle Position	0 to –60 (in 2 units)
Subtitle Brightness	Auto, 0 to –7
4:3 Aspect	<p>To select how to show images made for 4:3 aspect screens on a 16:9 aspect television</p> <p><b>Normal:</b> Laterally stretches images.</p> <p><b>Auto:</b> Expands 4:3 letterbox images to fill more of the screen. Other images appear in full in the center of the screen.</p> <p><b>Shrink:</b> Images appear in the center of the screen.</p> <p><b>Zoom:</b> Expands all images fill the screen. If your television has a similar feature, use it instead for a better effect.</p>
Just Fit Zoom	(→ page 20)
Manual Zoom	(→ page 20)
Bitrate Display	<b>RAM DVD-V VCD</b> On ↔ Off
GUI See-through	On ↔ Off
GUI Brightness	–3 to +3

## ■ Other Menu

Play as DVD-Video or Play as DVD-Audio	<p>While stopped</p> <ul style="list-style-type: none"> <li>Select "Play as DVD-Video" to play DVD-Video contents on DVD-Audio.</li> </ul>
Play as DVD-VR Play as HighMAT or Play as Data Disc	<p>While stopped</p> <ul style="list-style-type: none"> <li>Select "Play as Data Disc" to play JPEG files on DVD-RAM or to play HighMAT disc without using the HighMAT function.</li> </ul>



DVD

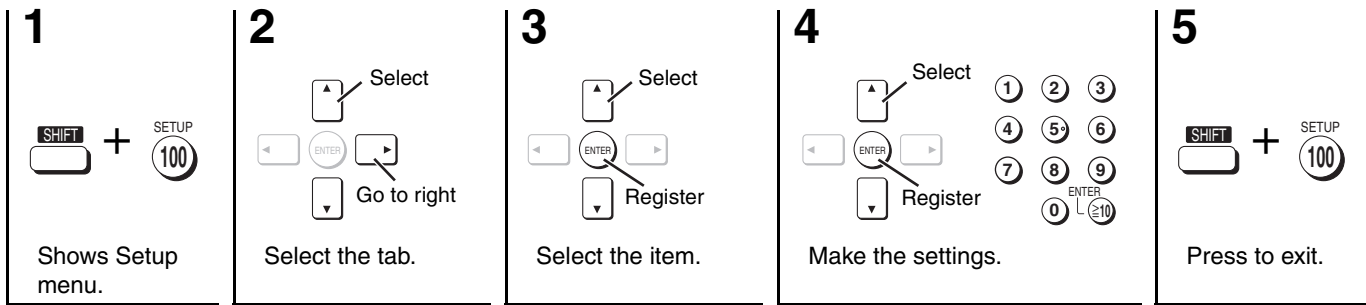

- The settings remain intact even if you switch the unit to standby.
- Underlined items are the factory preset.

The QUICK SETUP enables successive settings of the items in the shaded area.

## ■ “Disc” tab

<b>Audio</b> Choose the audio language.	<ul style="list-style-type: none"> <li>• <u>English</u></li> <li>• French</li> <li>• Spanish</li> <li>• Original*<sup>1</sup></li> <li>• Other*****<sup>2</sup></li> </ul>
<b>Subtitle</b> Choose the subtitle language.	<ul style="list-style-type: none"> <li>• <u>Automatic</u>*<sup>3</sup></li> <li>• English</li> <li>• French</li> <li>• Spanish</li> <li>• Other*****<sup>2</sup></li> </ul>
<b>Menus</b> Choose the language for disc menus.	<ul style="list-style-type: none"> <li>• <u>English</u></li> <li>• French</li> <li>• Spanish</li> <li>• Other*****<sup>2</sup></li> </ul> <p>Changing the menu language from QUICK SETUP also changes this setting.</p>
<b>Ratings</b> Set a ratings level to limit DVD-Video play. • Follow the on-screen instructions.	<p>Setting ratings (When level 8 is selected)</p> <ul style="list-style-type: none"> <li>• <u>8 No Limit</u></li> <li>• 1 to 7</li> <li>• 0 Lock All: To prevent play of discs without ratings levels.</li> </ul> <p>Changing ratings (When level 0–7 is selected)</p> <ul style="list-style-type: none"> <li>• Unlock Player</li> <li>• Change Level</li> <li>• Change Password</li> <li>• Temporary Unlock</li> </ul>

\*<sup>1</sup> The original language designed on the disc is selected.

\*<sup>2</sup> Input a code number referring to the table on page 29.

\*<sup>3</sup> If the language selected for “Audio” is not available, subtitle appears in that language (If available on the disc).

## ■ “Video” tab

<b>TV Aspect</b> Choose the setting to suit your television and preference.	<ul style="list-style-type: none"> <li>• <u>4:3 Pan&amp;Scan</u>: Regular aspect television (4:3) The sides of the widescreen picture are cut off so it fills the screen (unless prohibited by the disc).</li> <li>• 4:3 Letterbox: Regular aspect television (4:3) Widescreen picture is shown in the letterbox style.</li> <li>• 16:9: Widescreen television (16:9)</li> </ul>
<b>TV Type</b> Select to suit the type of television.	<ul style="list-style-type: none"> <li>• <u>Standard (Direct View TV)</u></li> <li>• CRT Projector</li> <li>• Projection TV</li> <li>• LCD TV/Projector</li> <li>• Plasma TV</li> </ul>
<b>Time Delay</b> When connected to a Plasma display, adjust if you notice the audio is out of the sync with the video.	<ul style="list-style-type: none"> <li>• <u>0 ms</u></li> <li>• 20 ms</li> <li>• 40 ms</li> <li>• 60 ms</li> <li>• 80 ms</li> <li>• 100 ms</li> </ul>
<b>Still Mode</b> Specify the type of picture shown when paused.	<ul style="list-style-type: none"> <li>• <u>Automatic</u></li> <li>• Field: The picture is not blurred, but picture quality is lower.</li> <li>• Frame: Overall quality is high, but the picture may appear blurred.</li> </ul>
<b>Black Level Control</b> Change the black level of the picture if you connected a television through the COMPONENT VIDEO OUT terminals.	<ul style="list-style-type: none"> <li>• <u>Lighter</u>: when connected through VIDEO OUT or S-VIDEO OUT.</li> <li>• Darker: when connected through COMPONENT VIDEO OUT (Y/P<sub>B</sub>/P<sub>R</sub>).</li> </ul>

## ■ “Audio” tab

<b>Dynamic range compression</b>	<ul style="list-style-type: none"> <li>• <u>Off</u></li> <li>• On: Adjusts for clarity even when the volume is low through compressing the range of the lowest sound level and the highest sound level. Convenient for late night viewing. (Only works with Dolby Digital)</li> </ul>
<b>Audio during Search</b>	<ul style="list-style-type: none"> <li>• <u>On</u></li> <li>• Off</li> </ul>
<b>Speaker Setting (→ page 29)</b> Set the delay time for your center and surround speakers.	<p>Center: <u>0.0</u>/1.0/2.0/3.0/4.0/5.0 ms</p> <p>Surround (L/R): <u>0.0</u>/5.0/10.0/15.0 ms</p>

■ “Display” tab

Menu Language	● English    ● Français    ● Español
On-Screen Messages	● On    ● Off

■ “Others” tab

HighMAT	● Enable ● Disable (Unable to use the HighMAT function.)
QUICK SETUP	● Yes    ● No
Re-initialize Setting This returns all values in the Setup menus to the default settings.	● Yes: The password screen is shown if “Ratings” (→ page 28) are set. Please enter the same password. After “INIT” on the display disappears, turn the unit off and on again. ● No

Changing the delay time (Speaker Setting)

(Effective when playing multi-channel audio)

For optimum listening with 5.1-channel sound, all the speakers, except for the subwoofer, should be the same distance from the seating position. If you have to place the center or surround speakers closer to the seating position, adjust the delay time to make up for the difference.

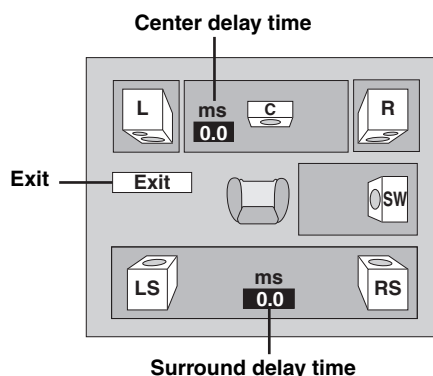

- 1 Press [▲ ▼] to select the delay time box and press [ENTER].
- 2 Press [▲ ▼] to adjust the delay time and press [ENTER].

If either distance (a) or (b) is less than (c), find the difference in the relevant table and change to the recommended setting.

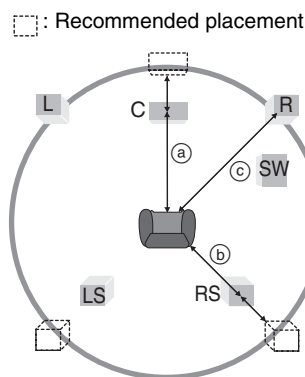

Ⓐ Center speaker

Difference	Setting
Approx. 34 cm (1 <sup>1</sup> / <sub>10</sub> feet)	1.0 ms
Approx. 68 cm (2 <sup>1</sup> / <sub>5</sub> feet)	2.0 ms
Approx. 102 cm (3 <sup>3</sup> / <sub>10</sub> feet)	3.0 ms
Approx. 136 cm (4 <sup>2</sup> / <sub>5</sub> feet)	4.0 ms
Approx. 170 cm (5 <sup>1</sup> / <sub>2</sub> feet)	5.0 ms

Ⓑ Surround speakers

Difference	Setting
Approx. 170 cm (5 <sup>1</sup> / <sub>2</sub> feet)	5.0 ms
Approx. 340 cm (11 feet)	10.0 ms
Approx. 510 cm (16 <sup>1</sup> / <sub>2</sub> feet)	15.0 ms

To finish the speaker setting

Press [◀] to select “Exit” and press [ENTER].

Language code list

Abkhazian: 6566	Chinese: 9072	Hausa: 7265	Lithuanian: 7684	Romanian: 8279	Telugu: 8469
Afar: 6565	Corsican: 6779	Hebrew: 7387	Macedonian: 7775	Russian: 8285	Thai: 8472
Afrikaans: 6570	Croatian: 7282	Hindi: 7273	Malagasy: 7771	Samoan: 8377	Tibetan: 6679
Albanian: 8381	Czech: 6783	Hungarian: 7285	Malay: 7783	Sanskrit: 8365	Tigrinya: 8473
Ameharic: 6577	Danish: 6865	Icelandic: 7383	Malayalam: 7776	Scots Gaelic: 7168	Tonga: 8479
Arabic: 6582	Dutch: 7876	Indonesian: 7378	Maltese: 7784	Serbian: 8382	Turkish: 8482
Armenian: 7289	English: 6978	Interlingua: 7365	Maori: 7773	Serbo-Croatian: 8372	Turkmen: 8475
Assamese: 6583	Esperanto: 6979	Irish: 7165	Marathi: 7782	Shona: 8378	Twi: 8487
Aymara: 6588	Estonian: 6984	Italian: 7384	Moldavian: 7779	Sindhi: 8368	Ukrainian: 8575
Azerbaijani: 6590	Faroese: 7079	Japanese: 7465	Mongolian: 7778	Singhalese: 8373	Urdu: 8582
Bashkir: 6665	Fiji: 7074	Javanese: 7487	Nauru: 7865	Slovak: 8375	Uzbek: 8590
Basque: 6985	Finnish: 7073	Kannada: 7578	Nepali: 7869	Slovenian: 8376	Vietnamese: 8673
Bengali; Bangla: 6678	French: 7082	Kashmiri: 7583	Norwegian: 7879	Somali: 8379	Volapük: 8679
Bhutani: 6890	Frisian: 7089	Kazakh: 7575	Oriya: 7982	Spanish: 6983	Welsh: 6789
Bihari: 6672	Galician: 7176	Kirghiz: 7589	Pashto, Pushto: 8083	Sundanese: 8385	Wolof: 8779
Breton: 6682	Georgian: 7565	Korean: 7579	Persian: 7065	Swahili: 8387	Xhosa: 8872
Bulgarian: 6671	German: 6869	Kurdish: 7585	Polish: 8076	Swedish: 8386	Yiddish: 7473
Burmese: 7789	Greek: 6976	Laotian: 7679	Portuguese: 8084	Tagalog: 8476	Yoruba: 8979
Byelorussian: 6669	Greenlandic: 7576	Latin: 7665	Punjabi: 8065	Tajik: 8471	Zulu: 9085
Cambodian: 7577	Guarani: 7178	Latvian, Lettish: 7686	Quechua: 8185	Tamil: 8465	
Catalan: 6765	Gujarati: 7185	Lingala: 7678	Rhaeto-Romance: 8277	Tatar: 8484	



Turn on the television and select the appropriate video input for the VHS.

- Put the remote control in VHS mode.**
- Turn on the unit.**
- Select "VHS".**
- Insert a tape.**  
Play starts automatically if you insert a prerecorded tape or one that has had its tab removed.
- Start play.**
- Adjust the volume.**  
--dB (Minimum) 0dB (Maximum)

Additional controls shown: Press to -Fast-forward and rewind -Cue and review. Press twice to Jet search. Stop. Stop. Play.



<b>Stop</b>		
<b>Pause</b>		• Press [▶] (PLAY) to start play.
<b>Slow</b>	<b>Press and hold</b> 	<ul style="list-style-type: none"> <li>• Pauses after 5 minutes and stops after 10 minutes.</li> <li>• There is no sound.</li> </ul>
<b>Fast-forward and rewind (while stopped)</b>		<ul style="list-style-type: none"> <li>• You can use fast-forward and rewind while using another source.</li> </ul>
<b>Cue and review (during play)</b>	<b>SLOW/SEARCH</b> 	<ul style="list-style-type: none"> <li>• Pauses after 5 minutes and stops after 10 minutes.</li> <li>• There is no sound.</li> <li>• Press and hold during play. Play restarts when you release the button.</li> </ul>
<b>Jet search (during play)</b>	<b>Press twice</b> 	<ul style="list-style-type: none"> <li>• Press [▶] (PLAY) to start play.</li> <li>• Pauses after 5 minutes and stops after 10 minutes.</li> <li>• There is no sound.</li> </ul>
<b>Jet rewind (while stopped)</b>	<b>SHIFT</b> 	• The tape counter does not appear.
<b>Eject</b>	<b>SHIFT</b> 	<ul style="list-style-type: none"> <li>• You can eject tapes when the unit is in standby mode. It switches back to standby mode once it ejects the tape.</li> <li>• You cannot eject tapes when the unit is recording or in timer recording standby mode.</li> </ul>

**Note**

- The tape moves at high speed during fast-forward, rewind, and jet rewind so the unit will make a noise. Also, it takes some time for the tape to stop after you press [■].
- The picture during cue, review, and jet search may be disrupted or otherwise affected on some televisions. During jet search at 35 times normal speed through EP or VP recordings, the picture may scroll vertically on some televisions. Change to 27-times normal speed if this occurs (→ page 40).

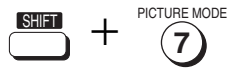

### Picture mode

Changes the picture quality to suit the material you are playing.



### Repeat play

Plays a program repeatedly.



### Manual tracking

Adjusts the tracking manually.



### Vertical locking adjustment

Adjusts the vertical hold to keep the picture from jiggling.

See below for details.



## Picture mode

Press [SHIFT]+[PICTURE MODE].

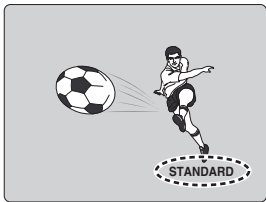

Each time you do this:

**STANDARD:** for recordings of television program (Factory preset)

**DYNAMIC:** Clear, vivid pictures for scenery and sports

**SOFT:** for prerecorded tapes

## Repeat play

Press and hold [▶] (PLAY) for about five seconds.

“R▶” appears on the television.

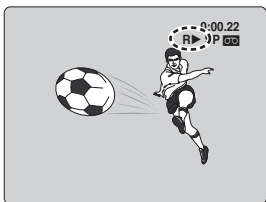

At the end of the program, the tape rewinds to the beginning of the program and plays it again. (It only works if there is a five-second blank at the end of the program.) This repeats until you cancel it.

### To cancel

Press [▶] (PLAY).

• It also cancels if you stop, pause, cue, or review.

## Manual tracking

This unit has an automatic digital tracking control feature that usually makes tracking adjustments for you, but you may need to do it manually, such as if noise appears on a tape recorded on other equipment.

### During play

Press [▲ CH] or [▼ CH].

Repeat until the noise disappears.

### To return to automatic digital tracking control

Press [▲ CH] and [▼ CH] at the same time.

### To remove the noise from a paused picture

Start slow play, then adjust the tracking.

### Note

This may not be effective on some tapes.

## Vertical locking adjustment

### While paused

Press [▲ CH] or [▼ CH].

Repeat until the jiggling stops.

### To return to the previous condition

Press [▲ CH] and [▼ CH] at the same time.

### Note

This may not work with some televisions. Try adjusting the vertical on the television itself.



VHS



### Preparation

- Turn on the television and select the video input for the VHS.



### Recording the television

See below for details.



## Recording the television

- 1 Insert the tape you want to record to.**  
Ensure its tab is in place (→ page 5).
- 2 Select the channel with the numbered buttons, [ $\wedge$  CH] or [ $\vee$  CH].**  
• To select with the numbered buttons:  
e.g. channel 2: [0] → [2]  
channel 23: [2] → [3]  
channel 123: [100] → [2] → [3]
- 3 Press [SPEED] to select the tape speed.**  
SP → EP → VP
- 4 Press [SHIFT] + [● REC] to start recording.**  
“REC” lights on the unit’s display.

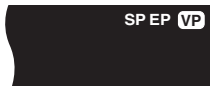

- To specify a time to stop recording (→ page 46, The sleep timer)

#### Note

- You cannot change channels while recording. You can change channels while paused.
- The unit will automatically return to the stop mode after a pause of 5 minutes while recording.
- Even if the tape you use is labeled “S-VHS”, the recordings you make do not use this system.
- You cannot record from the disc section to the unit.

#### Tape speeds

There are three tape speeds.

**SP:** You can record the length shown on the tape.

**EP:** Three times the length of SP mode.

**VP:** Five times the length of SP mode.

- You cannot play tapes recorded with VP mode on other equipment.
- It takes more time for automatic tracking to work when playing tapes recorded with VP mode, and it may not work at all with some tapes. Do tracking manually if this is the case (→ page 31).
- This unit can play tapes recorded with LP mode on other equipment (“LP” lights on the display).

#### To stop recording

Press [■].

#### To pause recording

Press [⏸].

Press it again or press [SHIFT] + [● REC] to continue recording.



## Using another source while recording

You can watch and listen to other content when the unit is in timer recording standby or during VHS recording.

### ■ Television (→ page 16)

- 1 During recording  
Press [TV] to put the remote control in TV mode.
- 2 Press [TV/VIDEO] then select the channel with the numbered buttons, [^ CH] or [v CH].

### ■ DVD (→ page 18)

- 1 During recording  
Press [DVD] to put the remote control in DVD mode.
- 2 Press [DVD/VHS] to select "DVD/CD".
- 3 Insert a disc and start play.

### ■ Radio (→ page 42)

- 1 During recording  
Press [TUNER] to put the remote control in TUNER mode.
- 2 Press [FM/AM] to select the radio band.
- 3 Select the radio channel with the numbered buttons, [^ CH] or [v CH].

#### Note

When you want to operate the VHS section again, be sure to press [VHS] to put the remote control in VHS mode.

## Recording from other equipment

You can record from other video equipment (video cassette recorder, camera, etc.)

### Preparation

- Connect the equipment to this unit's input terminals.  
– Turn the unit off before making connections.  
– If audio output on the other equipment is monaural, use a stereo-monaural conversion cable (not included).
- Insert the tape, ensuring its tab is in place and find the place to start recording.

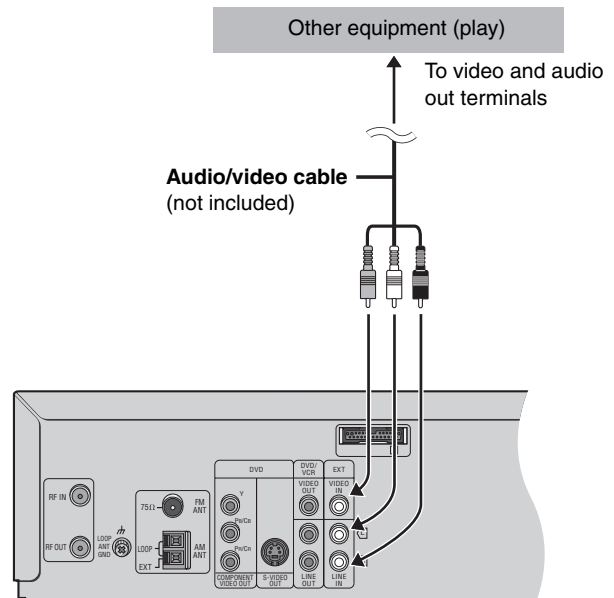

- 1 Press [^ CH] or [v CH] to select "AU" channel.



- 2 Press [▶] (PLAY) to find the place to start recording.
- 3 Press [||], then press [SHIFT]+[● REC] to put the unit in recording standby mode.
- 4 Press [SPEED] to select the tape speed.  
SP → EP → VP  
↑
- 5 Start play on the other equipment.
- 6 Press [||] when you want to start recording.

To stop  
Press [■].

- To make a timer program to record from other equipment (→ page 34)



VHS



You can create up to 16 timer recording programs. You can set the timer to record an individual program up to a month in advance, record at the same time on the same day every week, or at the same time daily.

### Preparation

- Make sure the unit's clock is correct (→ page 38 to adjust it if necessary).
- Insert a tape, ensuring its tab is in place (→ page 5).

PROG

## Timer recording

See below for details.



### 1 While stopped, press [PROG].

The timer-programming screen appears.

	DATE	CH	ON	OFF	1/2
1	27WE	2	8:02PM	9:30PM	SP
2	SU-SA	125	10:30AM	11:00AM	A
3	SU	14	3:00PM	4:00PM	VP
4	19TU	5	10:15PM	11:30PM	VP
5	28TH	AV	8:02PM	9:30PM	SP
6	30SA	4	7:10PM	7:55PM	VP
7	----	---	----	----	---
8	----	---	----	----	---

PROG.:ENTER    END:MENU

### 2 Press [PROG] to select an available line and press [ENTER].

### 3 Select "DATE" with [◀ ▶] and change it with [▲ ▼].

The date changes as follows:

- Current date
- ↓ ↑
- Next day up to one month later minus one day
- ↓ ↑
- Weekly timer: SU-SA → MO-SA → MO-FR
- ↓ ↑
- Daily timer: SU → MO → TU → WE → TH → FR → SA

### 4 Select "CH" with [◀ ▶] and change it with [▲ ▼].

Select "AU" when recording from other equipment (→ page 33).

### 5 Select "ON" with [◀ ▶] and change the start time with [▲ ▼].

### 6 Select "OFF" with [◀ ▶] and change the end time with [▲ ▼].

### 7 Press [SPEED] to change the tape speed.

SP → EP → VP → A\*

\* Auto SP/EP change function → page 35

### 8 If the Jet Navigator is on (→ page 36),

#### Select a category.

Press [▶] to select a category column. Press [▲ ▼] to enter the category selection menu. Then select a category with [▲ ▼ ◀ ▶], and confirm with [MENU].

You can also set and change the category in the navigator list (→ page 37).

Repeat steps 2 to 8 to make further timer programs.

### 9 Press [⏻] to put the unit on timer recording standby.

"⏻" lights on the unit's display.



#### To release the unit from timer recording standby

Press [⏻].

#### To stop recording

Press [⏻].

#### For your reference

The timer works whether the unit is on or not, so you can play DVDs or listen to the radio (→ page 33). Switch the unit to standby if you are finished.

## To check, correct, and cancel timer programs

### ■ To check a program

- 1 Press [PROG].  
The timer-programming screen appears.

### ■ To correct a program

While the timer programming screen is on the television,

- 1 Press [PROG] to highlight the program you want to correct and press [ENTER].
- 2 Select the item with [◀ ▶] and correct it with [▲ ▼].

	DATE	CH	ON	OFF	1/2
1	27WE	2	8:02PM	9:30PM	SP
2	SU-SA	125	10:30AM	11:00AM	A
3	SU	14	3:00PM	4:00PM	EP
4	19TU	5	10:15PM	11:30PM	VP
5	28TH	AV	8:02PM	9:30PM	SP
6	30SA	4	7:10PM	7:55PM	VP
7	---	---	---	---	---
8	---	---	---	---	---

SELECT [OK] -/+ [V]

### ■ To cancel a program

While the timer programming screen is on the television,

- 1 Press [PROG] to highlight the program you want to cancel.
- 2 Press [CANCEL].

## To clear the timer programming screen

Press [MENU].

## Auto SP/EP change

The unit switches tape speed to EP if it determines there is not enough tape to record the entire program in SP mode. The change may start at the beginning of the recording or part way through, depending on the remaining tape.

Before using this function, set the length of the tape you are using (→ page 40). It may not work correctly if you use tapes with irregular lengths.

Example program combination

1st program (30 min.)	2nd program (60 min.)	
Example program combination		
30 min. at SP	15 min. at SP	45 min. at EP (when using a 60-min. tape)

### Note

This function does not guarantee recording of the entire program.



The unit saves the date, channel, time, and category of the recordings you make and shows them on the Jet Navigator list, making it easier to find and play them. It can save the data for up to 14 recordings on a tape, for 20 different tapes, and for a total of 50 recordings.



Saving Jet Navigator data



Using the Jet Navigator to find programs

See below for details.



### Saving Jet Navigator data

- 1 Press [MENU] to display the “VHS MENU” screen.
- 2 Press [▲ ▼] to select “OPTION” menu and press [ENTER].
- 3 Press [▲ ▼] to select “JET NAVIGATOR” and press [◀ ▶] to change the setting to “ON”.

OPTION	1/2
OSD	●ON OFF
TAPE SELECT	
●T120 T160 T180	
BLUE BACK	●ON OFF
JET NAVIGATOR	●ON OFF
DELETE NAVIDATA	●NO YES
JET SEARCH	x27 ●x35
SELECT	: [ENTER] -/+ [ENTER]
END	: [MENU]

- 4 Press [▲ ▼] to select “TAPE SELECT” and press [◀ ▶] to set the length of the tape you are using.  
T120: T30, T60, T90, T120 tapes  
T160: T140, T160 tapes  
T180: T180 tapes
- 5 Record programs (→ pages 32–34).  
The unit makes the list as you record.

### Using the Jet Navigator to find programs

- 1 Press [NAVI] to show the “JET NAVIGATOR” screen.
- 2 Press [NAVI] to highlight the program you want to watch.  
The most recent program is highlighted first.

Once you have highlighted the program, wait about three seconds. The unit then starts searching for the program and starts play.

JET NAVIGATOR			
DATE	CH	ON	CATEGORY
10/18	1	10:30PM	MUSIC
10/19	124	3:00PM	SPORT
10/21	5	10:15AM	--
10/23	AV	8:02PM	--
10/26	4	7:10AM	EDUCA
10/27	2	8:02AM	--
10/27	12	8:30PM	--
SELECT:NAVI, [NAVI]		END:MENU	

The channel, date, and time of a recording appear on the television when play starts.

#### To clear the Jet Navigator list

Press [MENU].

#### ■ To delete the Jet Navigator on a video cassette tape

Keep [CANCEL] pressed for more than 5 seconds while the Jet Navigator list appears. “-” appears on the list.

#### ■ To delete all the Jet Navigator data stored in the unit’s memory (→ page 40).

### Setting categories

Set categories to make it easier to see what kind of programs are in the list.

- 1 Press [▶] while the program you want to categorize is highlighted.
- 2 Press [▲ ▼ ◀ ▶] to select a category and press [MENU] to confirm and return to the previous screen.

Category	Indication	Icon
Movie	MOVIE	
Music	MUSIC	
Drama	DRAMA	
Education	EDUCA	
Documentary	DOCUM	
Sports	SPORT	
Children	CHILD	
News	NEWS	
Others	OTHER	

#### To return to the Jet Navigator list

Press [MENU].

#### Note

- If you have already stored 14 programs on a tape and you then store another one, the new item is added and the oldest is deleted.
- "REMAINING PROGRAM 0 DELETE JET NAVIGATOR DATA" appears when you try to store more than fifty programs. The new item is added and the oldest item is deleted.
- "REMAINING CASSETTE 0 FOR JET NAVIGATOR DATA" appears when you try to store items for more than 20 tapes. Delete all the Jet Navigator data in the unit if you want to save the data for the tape (→ page 40).
- The list does not appear when playing tapes recorded on other equipment.
- Parts of the list data are recorded on the tape. Take care when recording over older recordings that you do not overlap it. It is recorded within a few minutes either side of the beginning of the recording (longer if you used EP or VP).

#### To demonstrate the Jet navigator function

Keep [NAVI] pressed for more than 5 seconds without inserting a cassette tape.

## Finding programs—VHS Index Search System (VISS)

Use the index marks on a tape to find sections to play. The unit adds index marks when recording starts. To add them manually during recording, press [SHIFT]+[● REC].

While stopped or during play

Press [◀◀] (backward) or [▶▶] (forward) to skip to the part you want to play.

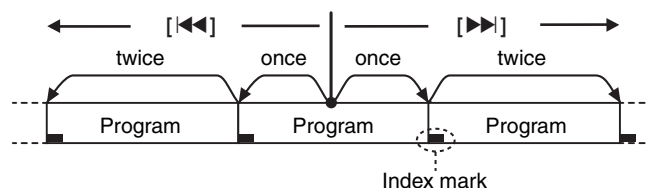

The channel, date, and time of a recording appear on the television when play restarts.

- Up to 20 index signals can be searched for in both directions.
- You can reduce the number of skips by pressing the opposite button.
- This feature may not work correctly if the marks are too close together. Make recordings of at least 15 minutes (25 minutes in VP mode).





- 1** Shows VHS MENU.
- 2** Select the item.
- 3** Make the settings.
- 4** Press to exit.

• The settings remain intact even if you switch the unit to standby.

See below and the following page for details (while VHS MENU is displayed).

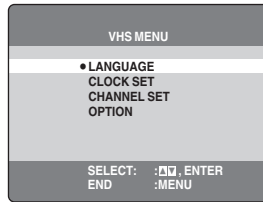

## LANGUAGE

Select the language for these menus and other on screen displays.

- 1** Press [**▲ ▼**] to select “LANGUAGE” and press [ENTER].
- 2** Press [**▲ ▼**] to choose the preferred language.
  - ENGLISH (Factory preset)
  - ESPAÑOL
  - FRANÇAIS

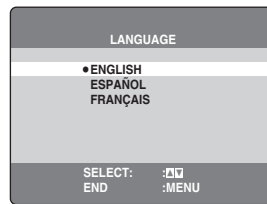

Press [MENU] to confirm and return to the previous screen.

## CLOCK SET

The clock is set automatically after Plug-in Auto Tuning (→ page 15). Do the following if you want to set it again or if the time is not set correctly.

- 1** Press [**▲ ▼**] to select “CLOCK SET” and press [ENTER].

### AUTO CLOCK SET

- 2** Press [**▲ ▼**] to select “AUTO CLOCK SET” and press [ENTER].

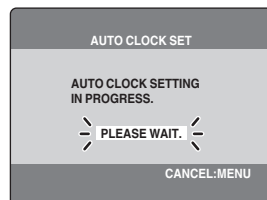

Auto setting starts. This can take some time.

**To stop partway through**  
Press [MENU].

### ■ If the unit cannot set the clock automatically

The MANUAL CLOCK SET screen appears. Set the time manually (→ below).

### MANUAL CLOCK SET

- 2** Press [**▲ ▼**] to select “MANUAL CLOCK SET” and press [ENTER].
- 3** Press [**◀ ▶**] to select the item you want to change and press [**▲ ▼**] to change the setting.
- 4** Press [MENU] to start the clock and exit the setting screen.

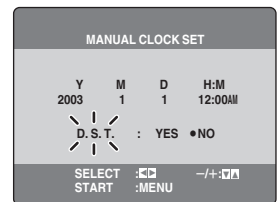

### ■ Time reset function

To return the clock to the exact hour, wait until the clock in the MANUAL CLOCK SET screen is within 2 minutes either side of the hour (e.g., between 11:58:00 and 12:01:59) press [MENU] to clear the screen. The clock changes to the exact hour.

## CHANNEL SET

The unit tunes automatically after you plug it in and turn it on for the first time (→ page 15, Plug-in Auto Tuning), but you can start the process again if necessary.

• Make sure you have tuned to a television channel. This does not work if you have selected “AU” channel.

### 1 Press [▲ ▼] to select “CHANNEL SET” and press [ENTER].

#### ANTENNA SYSTEM

### 2 Press [▲ ▼] to select “ANTENNA SYSTEM” and press [ENTER].

### 3 Press [▲ ▼] to select “TV” or “CATV” to suit the type of antenna you are using.

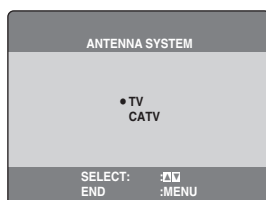

Channels are set corresponding to the antenna system you select. This is set automatically when you do Plug-in Auto Tuning.

#### To exit the settings screen

Press [MENU] until the screen disappears.

#### AUTO

Auto tuning searches for TV stations and memorizes every tuned program position. Other program positions are skipped. (Channel range → right)

### 2 Press [▲ ▼] to select “AUTO” and press [ENTER].

Auto tuning starts. It takes three or more minutes to complete.

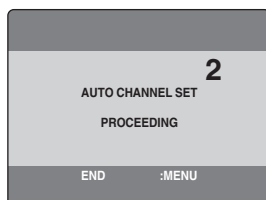

#### To stop partway through

Press [MENU].

#### MANUAL

You can manually preset channels that are skipped when using the auto channel setting, and manually skip channels that are preset.

### 2 Press [▲ ▼] to select “MANUAL” and press [ENTER].

### 3 Press [▲ ▼] to select “CH” and [◀ ▶] to select the channel.

### 4 Press [▲ ▼] to select “BLANK” and [◀ ▶] to select “ON” or “OFF”.

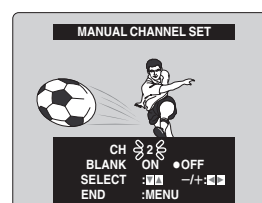

#### To exit the settings screen

Press [MENU] until the screen disappears.

#### ■ Channel range

##### • TV mode

Band	Airwaves
VHF	2–13
UHF	14–69

##### • CATV mode

Band	Cable
VHF	2–13
CATV LOW BAND	95–99
CATV MID/SUPER BAND	14–36
CATV HYPER BAND	37–65
ULTRA BAND	66–94
	100–125
SPECIAL CATV CHANNEL	1



VHS

## OPTION

- 1 While VHS MENU is displayed (→ page 38)  
Press [**▲ ▼**] to select the “OPTION” and press [ENTER].
- 2 Press [**▲ ▼**] to select the item and press [**◀ ▶**] to change the setting (→ below).

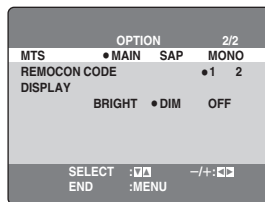
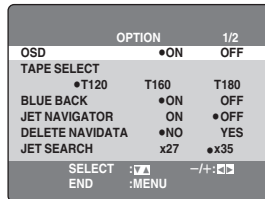

## To exit the settings screen

Press [MENU] until the screen disappears.

## REMOTE CONTROL

Panasonic video cassette recorders use the same remote control system so they may respond unintentionally to a command from this remote control. Change the code on this unit and its remote control (the two must match) if you place another Panasonic video cassette recorder close together.

- Use “1”, the factory preset, under normal circumstances.

- 1 While OPTION menu is displayed  
Press [**▲ ▼**] to select the “REMOTE CONTROL” and press [ENTER].
- 2 Press [**◀ ▶**] to select the code (1 or 2) and press [ENTER].  
The remote control code on the unit has been set.
- 3 While pressing [ENTER] on the remote control, press and hold the numbered button ([1] or [2]) corresponding to the code you selected in step 2.  
The remote control code on the remote control has been set.

The following is displayed when you use a remote control with the different code.



The unit's remote control code

Change its code to match the unit's (→ step 3).



VHS

Items	Settings (Underlined items are the factory preset.)
<b>OSD</b> (→ page 41, On-screen display)	<u>ON</u> : Messages appear on the television for about five seconds after you perform operations. OFF: Messages do not appear.
<b>TAPE SELECT</b> Set the length of tape you are using so the unit can show the correct remaining time.	<u>T120</u> : T30, T60, T90, T120 tapes T160: T140, T160 tapes T180: T180 tapes
<b>BLUE BACK</b>	<u>ON</u> : The screen shows a blue background when you play unrecorded portions. OFF
<b>JET NAVIGATOR</b> (→ page 36)	<u>ON</u> : Jet Navigator data automatically registered. <u>OFF</u> : Data not registered.
<b>DELETE NAVIDATA</b> Delete all the Navigation data registered in the unit. See page 36 to delete data on a single tape.	<u>NO</u> YES: Then press [ENTER] when you want to delete all the Jet navigator data.
<b>JET SEARCH</b> (→ page 30) Set the speed for JET SEARCH when playing EP and VP tapes.	×27 <u>×35</u> Select ×27 if the picture is poor at ×35.
<b>MTS</b> (→ page 41, Changing audio) Set the MTS (Multi-channel Television Sound Stereo) reception type.	<u>MAIN</u> : To receive stereo broadcasts. SAP: To receive SAP when being broadcast. MONO: To receive monaural broadcasts (e.g., when reception is poor).
<b>REMOTE CONTROL</b>	<u>1</u> 2
<b>DISPLAY</b> Set the brightness of the unit's display when the unit is in standby mode.	<u>BRIGHT</u> : The display is bright all the time. <u>DIM</u> : The display dims when the unit is in standby mode. OFF: The display turns off when the unit is in standby mode.



## On-screen display

To see these displays, set the OSD item in the OPTION menu to ON.

### Press [OSD/DISPLAY].

The time and operation details appear on the screen for about 5 seconds.

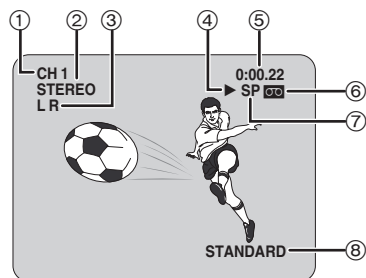

①	<b>Channel display</b> Displays the cable television channel or television channel currently being received.
②	<b>STEREO/SAP indication</b> Indicates when a program is broadcast in stereo or SAP. → right for audio type details.
③	<b>L and R indicators</b> The Left (L) and Right (R) indicators show which sound mode is selected as follows: Stereo: Both the L and R indicators appear. L: The L indicator appears. R: The R indicator appears. Normal: Neither the L and R indicator appears.
④	<b>Tape running display</b> Shows operations taking place.
⑤	<b>Shows the time and tape counter</b> Press [OSD/DISPLAY]. The display changes as follows. Present time → Tape counter → Remaining tape time ↑ Using index search: "S 01" to "S 20" is displayed. Using jet rewind: "J.REW" is displayed. ● Press [SHIFT]+[RESET] to reset the tape counter (elapsed time) to "0:00.00". ● The remaining time is approximate. It will be incorrect if you set the wrong tape time in the TAPE SELECT item in the OPTION menu and if the tape is of poor quality.
⑥	<b>Cassette in indicator</b> Shows whether you have loaded a cassette.
⑦	<b>Tape speed indicator</b> (→ page 32)
⑧	<b>Picture mode indicator</b> (→ page 31)

#### Note

- These displays do not appear when paused or during slow play.
- The on-screen display may be disturbed depending on the playback tape or the input signal.

## Changing audio

When a stereo and/or SAP broadcast is received, "STEREO" and/or "SAP" appear showing the type of broadcast.

### To change the audio

#### Press [SHIFT]+[AUDIO].

The audio changes as follows:

- When playing a tape:  
LR → L → R → Normal audio track  
↑
- While watching the television:  
LR → L → R  
↑

The table below shows the TV broadcast type, "MTS" settings, and audio recording patterns.

TV broadcast	MTS setting	Audio track		
		Normal (Mono)	Hi-Fi	
			Left	Right
Mono	MAIN or SAP	Mono	Mono	Mono
Stereo	MAIN or SAP	L+R (Mixed)	Left	Right
Mono and SAP	MAIN	Mono	Mono	Mono
	SAP	Mono	Mono	SAP
Stereo and SAP	MAIN	L+R (Mixed)	Left	Right
	SAP	L+R (Mixed)	L+R (Mixed)	SAP

Be sure that "MTS" is set to "MAIN" or "SAP" to record on the Hi-Fi audio tracks.

#### Note

- Switch to "MONO" for viewing or recording if a stereo or SAP broadcast is impaired by poor reception.
- To resume stereophonic recording, set "MTS" to "MAIN" or "SAP".

### Auto bilingual choice function

When you play back recordings of stereo or SAP broadcasts, these audio types are automatically selected. The unit may select a different type if you start play midway through the program. Press [SHIFT]+[AUDIO] to change the type if this occurs.

This function does not work if:

- The tape was recorded on a deck without this system.
- The tape is a recording from external equipment.



# The radio

Press [TUNER] to put the remote control in TUNER mode.

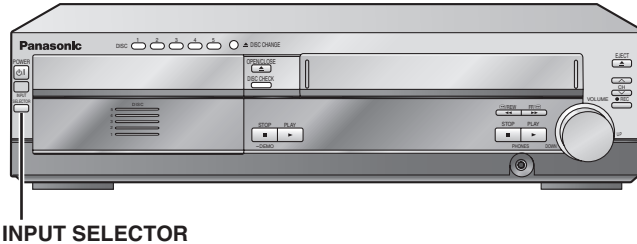

INPUT SELECTOR

## Automatic presetting

Up to 15 stations can each be set in the FM and AM bands.

- 1 Press [FM/AM] to select “FM”.
- 2 Press [◀◀] or [▶▶] to tune to the lowest frequency (“FM 87.9” MHz or “FM 87.5” MHz).
- 3 Press and hold [ENTER].

Release the button when “FM AUTO” is displayed.

The tuner presets all the stations it can receive into the channels in ascending order.

•“SET OK” is displayed when the stations are set. The last station to be set is then played.

- 4 Repeat steps 1 to 3 to set the AM bands.

## Selecting the preset channels

- 1 Press [FM/AM] to select “FM” or “AM”.
- 2 Press the numbered buttons to select the channel.

Alternatively, press [^ CH] or [v CH].

To select a 2-digit number

e.g. 12: [≥10] → [1] → [2].



When a stereo FM broadcast is being received.



■ If noise is excessive in FM Press [PLAY MODE] to display “MONO”.

Press [PLAY MODE] again to cancel the mode.

The mode is also canceled when you change the frequency.

MONO

## Manual tuning

- 1 Press [FM/AM] to select “FM” or “AM”.
- 2 Press [◀◀] or [▶▶] to select the frequency.  
Press and hold [◀◀] or [▶▶] until the frequency starts scrolling to start automatic tuning. Tuning stops when a station is found.

### Presetting the channel one by one

- 1 Tune to the station (→ left).
- 2 Press [ENTER].
- 3 While “PGM” is flashing on the display Press the numbered buttons to select a channel.  
Alternatively, press [^ CH] or [v CH] then press [ENTER].



The station occupying a channel is erased if another station is preset to that channel.

### ■ FM frequency step

#### Main unit only

The step is factory-set to 0.2 MHz, but you can change it to receive broadcasts allocated in 0.1-MHz steps.

- 1 Press [INPUT SELECTOR] on the main unit to select “FM”.
- 2 Press and hold [INPUT SELECTOR].

After a few seconds the display changes to show the current minimum frequency. Continue to hold the button down. The minimum frequency changes and the step is changed.

To return to the original step, repeat the above steps.

#### Note

Any FM/AM frequencies preset in channels will be changed by this procedure. Preset them again.



## Optional FM antenna connection

Use FM outdoor antenna if radio reception is poor.

- Disconnect the outdoor antenna when the unit is not in use.
- Do not use the outdoor antenna during an electrical storm.

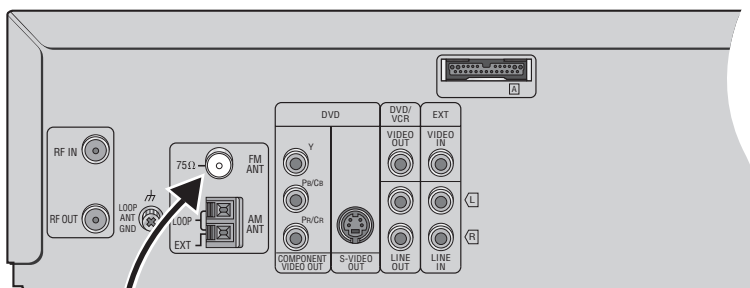

### FM outdoor antenna (Using a television antenna)

- Disconnect the FM indoor antenna.
  - The antenna should be installed by a competent technician.
- Rework your outdoor antenna's 75 Ω coaxial cable as follows.

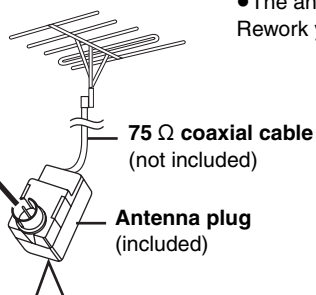

① Remove a piece of the outer vinyl insulator.

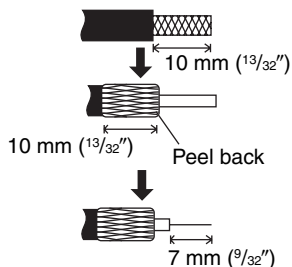

② Carefully pull the tabs apart to remove the cover.

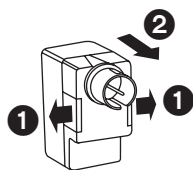

③ Install the coaxial cable. Clamp the cable conductor, and wind it on so that it does not contact anything else.

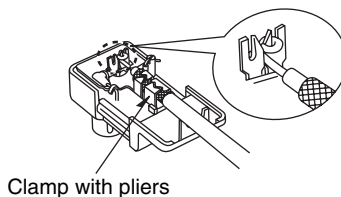

④ Attach the cover.

Manufactured under license from Dolby Laboratories. "Dolby", "Pro Logic" and the double-D symbol are trademarks of Dolby Laboratories.

"DTS" and "DTS Digital Surround" are registered trademarks of Digital Theater Systems, Inc.

Apparatus Claims of U.S. Patent Nos. 4,631,603, 4,577,216, and 4,819,098, licensed for limited viewing uses only.

This product incorporates copyright protection technology that is protected by method claims of certain U.S. patents and other intellectual property rights owned by Macrovision Corporation and other rights owners. Use of this copyright protection technology must be authorized by Macrovision Corporation, and is intended for home and other limited viewing uses only unless otherwise authorized by Macrovision Corporation. Reverse engineering or disassembly is prohibited.



# Sound field and sound quality



## Sound Field Control

Changes the sound quality.



## Super Surround

Adds surround effects to stereo sound.



## Center Focus

For clearer dialogues.



**DVD** only

## Dolby Pro Logic II

Changes stereo sound to surround sound.



**VHS**, TUNER only

## Dolby Pro Logic

Changes stereo sound to surround sound.

### Note

You may experience a reduction in sound quality when these sound field systems are used with some sources. If this occurs, turn the sound field system off.

See below for details.



## Sound Field Control

### Press [SFC].

Each time you press the button:

**HEAVY:** Adds punch to rock.

**CLEAR:** Clarifies higher sounds.

**SOFT:** For background music.

**DISCO:** Reverberates sound to make you feel like you are in a disco.

**LIVE:** Makes vocals more alive.

**HALL:** Expands sound to make you feel like you are in a hall.

**FLAT:** Cancel (no effect is added) (factory preset).

SFC

### To check the current setting

Press [SFC].

## Super Surround

### Press [SUPER SRND].

Each time you press the button:

**MUSIC:** Adds surround effects to stereo sources.

**MOVIE:** Use this mode when playing movie software.

**PARTY:** Sound is in stereo regardless of the direction you are facing.

S.SRND

- You can adjust the volume of the surround speakers to get the best surround effect (→ page 45, Speaker level adjustments).
- Turn Super Surround off when playing a DVD recorded with Dolby Digital or DTS. The surround effects will not be reproduced correctly if this is left on.
- When Super Surround is on, Dolby Pro Logic II or Dolby Pro Logic turns off.

## Center Focus

(Discs where the dialogue is recorded in the center channel)

You can make the sound of the center speaker seem like it is coming from within the television.

### Press [SHIFT] + [C.FOCUS].

C.F



CENTER FOCUS ON ←→ CENTER FOCUS OFF

- This does not work or have less effect when Super Surround, Dolby Pro Logic II or Dolby Pro Logic is turned on.

## Dolby Pro Logic II

Dolby Pro Logic II is an advanced decoder that derives 5 channel surround (Left and Right Front, Center, Left and Right Surround) from any stereo program material, whether or not it has been specifically Dolby Surround encoded.

### Press [DOLBY II].

Each time you press the button:

**MOVIE:** Movie software, recorded in Dolby Surround.

**MUSIC:** Stereo sources.

DOLBY II

- This does not work when playing multi-channel audio.

## Dolby Pro Logic

Dolby Pro Logic is an active process that enhances sound localization through the use of a high separation decoding method providing improved spatiality and a wider listening area. The sense of directionality is enhanced by the Left, Center, Right and Surround channels. Dolby Pro Logic decoding is best utilized with sources encoded in Dolby Surround.

### Press [DOLBY].

DOLBY

### To cancel

Press [DOLBY II] again.

- This does not work when playing multi-channel audio.

Software encoded with Dolby Surround can be identified with this mark (DVD, CD, Video CD, Laser Disc, Video tape).





**DVD** only

### Custom Sound Memory

Stores up to 30 sound setting (one setting per disc).

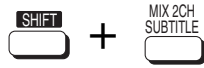

**DVD** only

### Down-mixing

Down-mixes multi-channel signals to 2 channels.



### Subwoofer level

Adjusts the amount of bass.

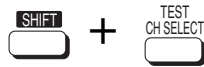

### Speaker level adjustments

See below for details.



## Custom Sound Memory

**DVD-A** **DVD-V** **VCD** **CD**

### Available sound settings:

Dolby Pro Logic II, Subwoofer level, Center Focus, Sound Field Control, Super Surround

After making the sound field or sound quality settings

Press and hold  
**[SHIFT]+[C.S.M.]**.



### Recall the settings

The unit recalls the settings when you play the disc again.

- The settings are replaced if you change them.
- When you store settings for the 31st disc, the settings for the earliest disc are cleared.
- Press [SHIFT]+[C.S.M.] while "CSM" is displayed and the settings return to those that were current before the settings were recalled.
- Press [SHIFT]+[C.S.M.] while "CSM" is out and you are playing a disc for which you stored settings and those settings are recalled.

## Down-mixing

You can output the down-mixed 2 channel signal when necessary (e.g. when you intent to record 5.1ch sound on other recording equipment).

Press  
**[SHIFT]+[MIX 2CH]**.



### To cancel

Press [SHIFT]+[MIX 2CH] again.

### Note

When "D.MIX" flashes on the display, the disc contains multiple-channel signals that cannot be down-mixed. **DVD-A**

## Subwoofer level

Press **[SUBWOOFER LEVEL]**.



SUB W 1 → SUB W 2 → SUB W 3 → SUB W 4 (factory preset)



## Speaker level adjustments

This is the one of ways to get the appropriate surround effect. Adjust the speaker level to the same level as the front speakers.

### 1 Press [SHIFT]+[TEST] to output a test signal.

Lch: Front left  
Cch: Center  
Rch: Front right  
RSch: Right surround  
LSch: Left surround

- There is no output from SW (subwoofer) channel.

### 2 Press [VOLUME, +] or [-] to set the volume level normally used for listening.

### 3 Press [▲] (increase) or [▼] (decrease) to adjust the speaker level for each speaker.

C, RS, LS: -6 dB to +6 dB  
(L, R: Only the balance is adjustable.)

- To adjust the balance of the front speakers  
While outputting the test signal, press [◀ ▶].

### To stop the test signal

Press [SHIFT]+[TEST] again.

### To adjust speaker level during play

#### 1 Press [CH SELECT] to select the speaker.

L → C → R → RS → LS → SW

SW: Subwoofer

- You can only adjust SWch if the disc includes a subwoofer channel.
- SWch does not appear on the display and is not adjustable when Dolby Pro Logic II or Dolby Pro Logic turned on.

#### 2 Press [▲] (increase) or [▼] (decrease) to adjust the speaker level for each speaker.

C, RS, LS, SW: -6 dB to +6 dB  
(L, R: Only the balance is adjustable.)

- To adjust the balance of the front speakers  
During play, press [◀ ▶].



## Other convenient features

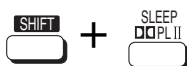

### Sleep timer

Turns the unit off after a set time.



### Muting

Mutes the sound.

See below for details.



### Sleep timer

Press **[SHIFT]+[SLEEP]** to select the time (in minutes).

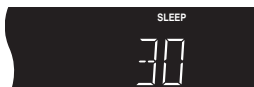

SLEEP 30 → SLEEP 60 → SLEEP 90  
 ↑ OFF ← SLEEP 120 ←

#### To cancel the timer

Press **[SHIFT]+[SLEEP]** to select "OFF".

#### To confirm the remaining time

Press **[SHIFT]+[SLEEP]** again.

#### To change the setting

Repeat the procedure from the beginning.

- The VHS's timer program recording functions even when the unit is turned off by the sleep timer.

### Muting

Press **[MUTING]**.



#### To cancel

Press **[MUTING]** again or reduce the volume to minimum (– dB), then raise it to the required level.

Muting is canceled when you switch the unit to standby.

### Using headphones

- 1 Reduce the volume and connect the headphones (not included).

Headphone plug type: 3.5 mm (1/8") stereo

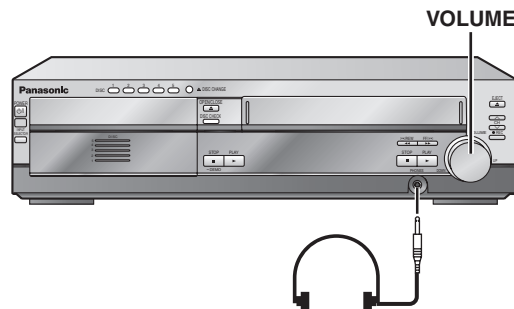

- 2 Adjust headphone volume with **[VOLUME DOWN, UP]**.

- Audio is automatically switched to stereo (2-channel).

#### Note

Avoid listening for prolonged periods of time to prevent hearing damage.

## Other speaker setup options

### Attaching to a wall

#### Note

- The wall or pillar on which the speakers are to be attached should be capable of supporting 10 kg (22 lb.) per screw. Consult a qualified building contractor when attaching the speakers to wall. Improper attachment may result in damage to the wall and speakers.
- Do not attempt to attach these speakers to walls using methods other than those described in this manual.

### 1 Drive a screw (not included) into a wall.

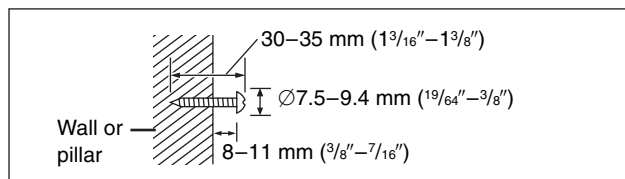

### 2 Fit the speaker securely onto the screw(s) with the hole(s).

#### Front and surround speakers

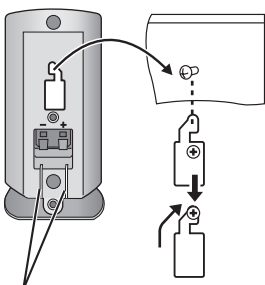

So that the speaker fits up against the wall squarely, be sure to press the speaker cable down into the groove.

#### Center speaker

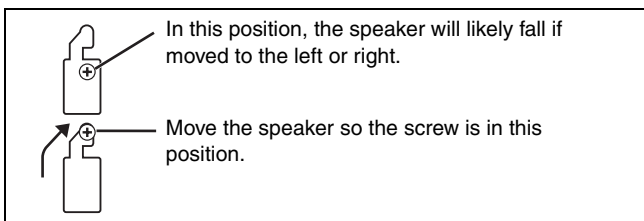
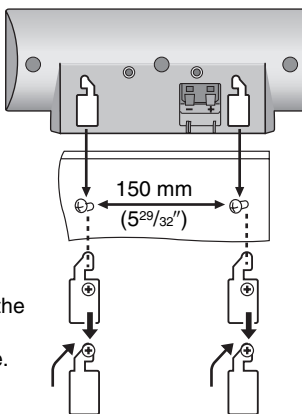

### Fitting speaker stands (not included)

Ensure the stands meet these conditions before purchasing them. Observe the diameter and length of the screws and the distance between screws as shown in the diagram.

- The stands must be able to support over 10 kg (22 lb.).
- The stands must be stable even if the speakers are in a high position.

#### e.g. Front and surround speaker

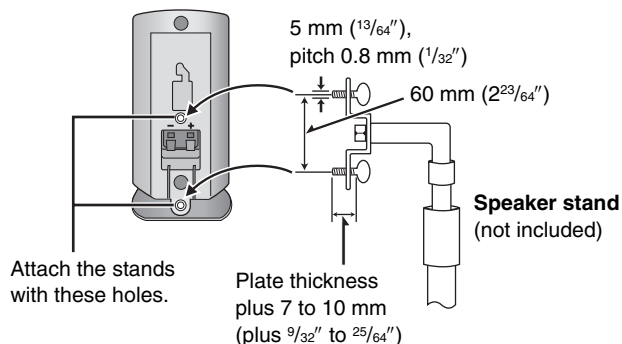

## Optional connections

### Listening to an external source/ Recording to other equipment

#### Audio cable (not included)

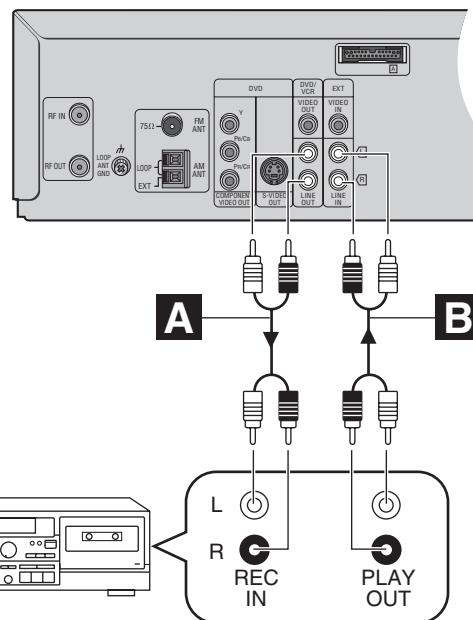
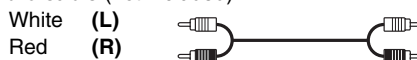

#### A You can record sound from discs, video cassette tapes, or radio, etc., to a tape deck.

##### 1 Discs

Press [DVD/VHS] to select "DVD/CD" as the source.

##### Video cassette tapes

Press [DVD/VHS] to select "VHS" as the source.

##### Radio

Press [FM/AM] to select "FM" or "AM".

##### 2 Start recording and play.

Refer to the manual of the other unit for details.

#### B You can playback the sound from a tape deck/laser disc player, etc., through this unit's speakers.

- Press [VHS] to put the remote control in VHS mode.
- Press [DVD/VHS] to select "VHS" as the source.
- Press [ $\wedge$  CH] or [ $\vee$  CH] to select "AU" channel.
- Start play.

#### When connecting a record player

We recommend using a record player with a built-in phono equalizer. If your player doesn't have a built-in equalizer, connect it first to a separate equalizer and then to the unit.



- The equipment connections described are examples.
- Peripheral equipment and optional cables sold separately unless otherwise indicated.
- Before connection, turn off all equipment and read the appropriate operating instructions.

## Connecting a cable TV box/satellite receiver

- You need to subscribe to a cable TV or satellite TV service, to enjoy viewing their programming.
- Consult your service provider regarding appropriate cable TV box or satellite receiver.
- Select the applicable input on your television to view the output from your cable TV box/satellite receiver through this unit.
- The signal from the cable TV box or satellite receiver passes through this unit to the television even when this unit is turned off.
- Change the video input on the television when you want to watch another program while recording.
- You cannot do a timer recording unless the channel is first selected on the cable TV box or satellite receiver.

### One cable TV box/satellite receiver

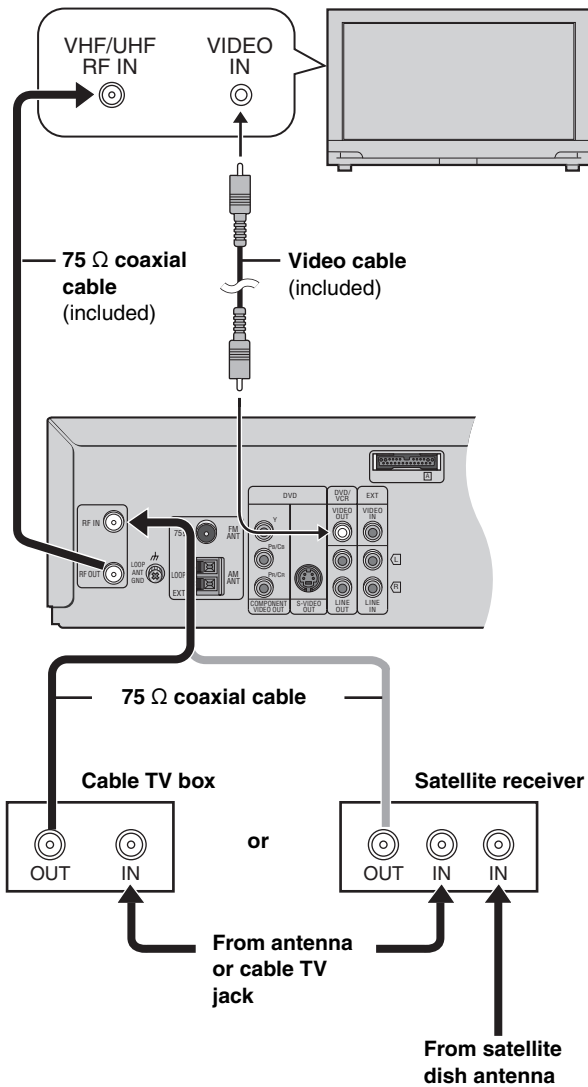

### Two cable TV boxes

You can record and view both scrambled and unscrambled channels if connections are made as shown in the diagram below.

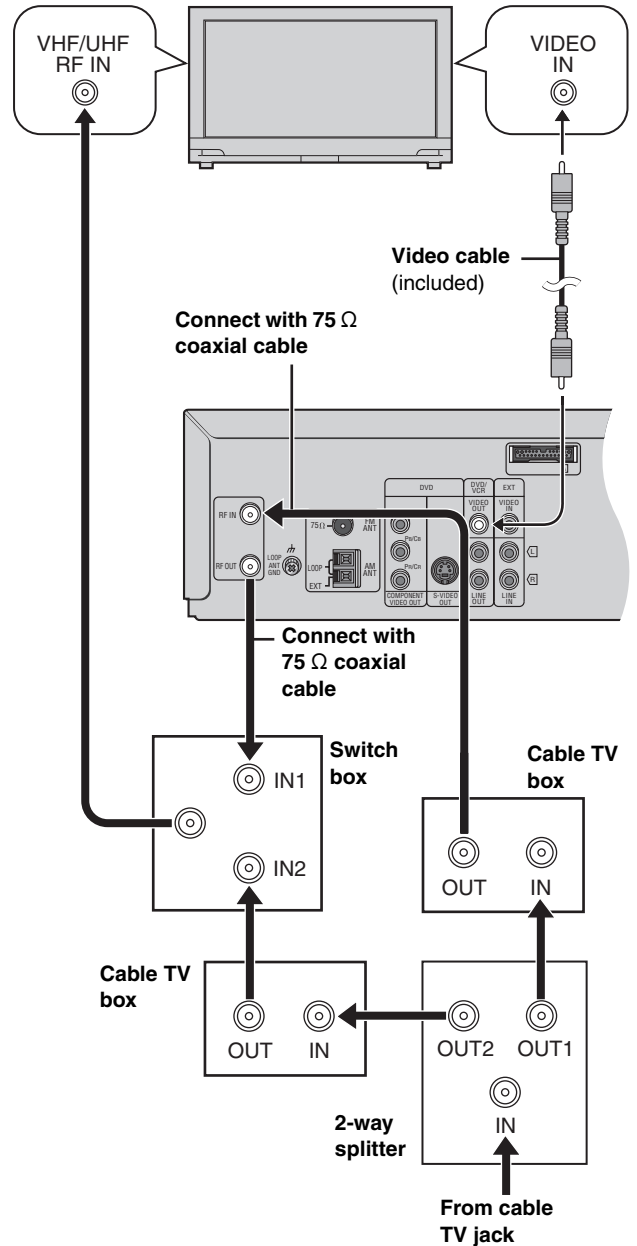

#### Note

When a home satellite system (Dishnetwork/DSS) is connected, auto tuning and auto clock setting may not operate properly. Set the clock manually (→ page 38).





## If the antenna connector doesn't match

### Other antenna connections to the unit

Use one of the following connections to suit the antenna lead.

#### ■ A single twin lead

- If your television has both lead and coaxial VHF terminals, use the lead connection to minimize signal loss.

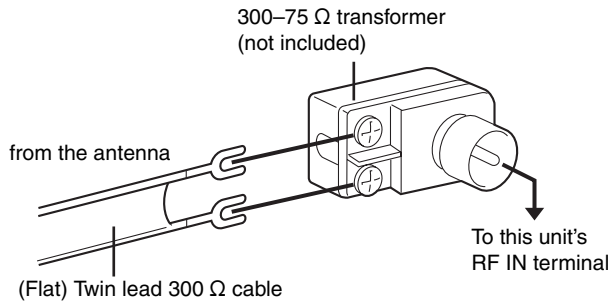

#### ■ A twin lead and a coaxial cable

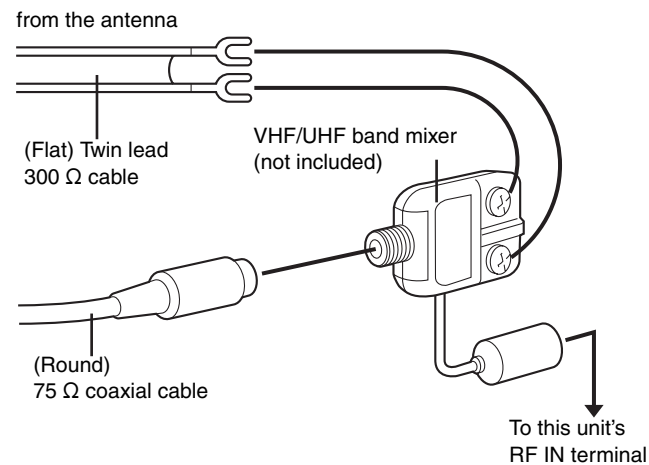

#### ■ Two twin leads

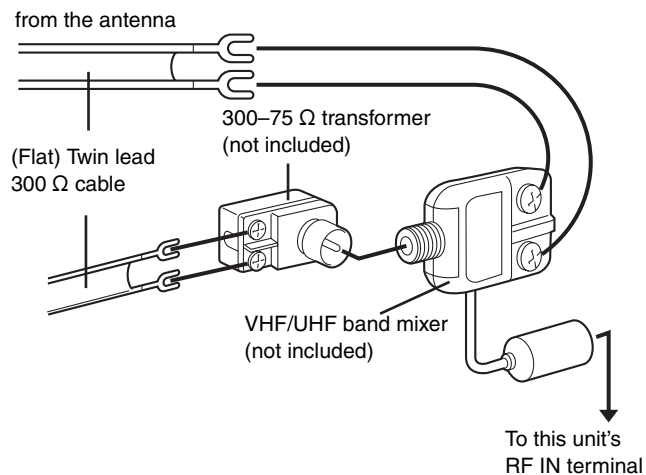

### Other antenna connections from the unit to the television

Use one of the following connections to suit the antenna terminals on your television. Refer to the television's operating instructions.

#### ■ A twin lead and coaxial plug terminal

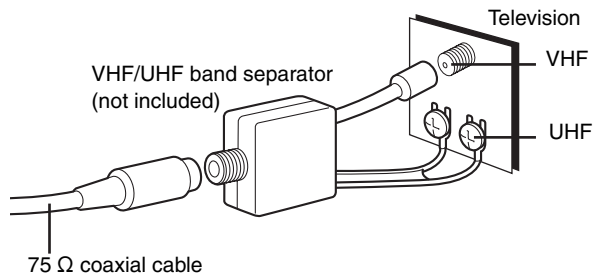

#### ■ A twin lead terminal

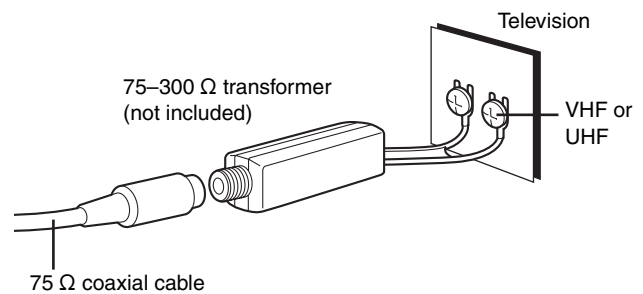

#### ■ Two twin lead terminals

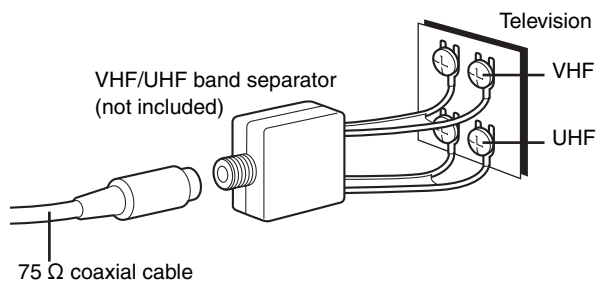

#### ■ Multiple antenna terminals

- Connect to one of the ANT terminals, then change the television's setting as necessary.

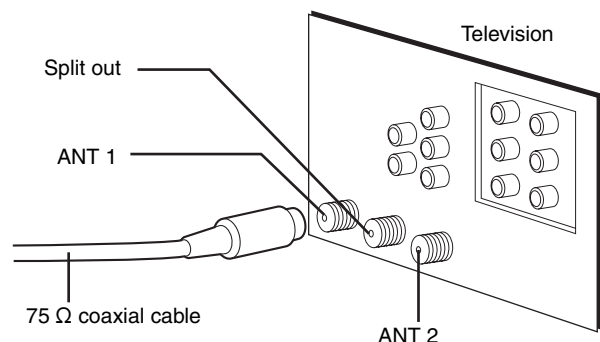

# Troubleshooting guide

Before requesting service, make the following checks. If you are in doubt about some of the check points, or if the remedies indicated in the chart do not solve the problem, refer to the "Customer Services Directory" on page 54 if you reside in the U.S.A., or refer to the "Product information" on page 55 if you reside in Canada.

Power		Page
No power.	● Insert the AC power supply cords and system cable securely.	14
The unit is automatically switched to the standby mode.	● The Sleep timer functioned.	46

## No operation

No response when any buttons pressed.	<ul style="list-style-type: none"> <li>● This unit cannot play discs other than the ones listed in these operating instructions.</li> <li>● The unit may not be operating properly due to lightning, static electricity or some other external factor. Turn the unit off and then back to ON. Alternatively, turn the unit off, disconnect both AC power supply cords, and then reconnect them.</li> <li>● Condensation has formed: Wait 1 to 2 hours for it to evaporate.</li> </ul>	6 — —
No response when remote control buttons pressed.	<ul style="list-style-type: none"> <li>● Check that the batteries are installed correctly.</li> <li>● The batteries are depleted: Replace them with new ones.</li> <li>● Point the remote control at the remote control sensor and operate.</li> </ul>	4 4 18
No picture or sound.	<ul style="list-style-type: none"> <li>● Check the video and audio connection.</li> <li>● Check the power or input setting of the connected equipment.</li> <li>● Check that the DVD-RAM has something recorded on it.</li> </ul>	11–14 — —
You have forgotten your ratings password. Reset all the settings to Factory Preset.	<ul style="list-style-type: none"> <li>● While stopped and "DVD/CD" is the source, press and hold [◀◀] (REW), [▶▶] (PLAY) (DVD) and [▲] (OPEN/CLOSE) on the main unit until "Initialized" disappears from the television. Turn the unit off and on again. All settings will return to the default values.</li> </ul>	—
Cannot operate the VHS.	<ul style="list-style-type: none"> <li>● Press [VHS] to switch the remote control mode to VHS.</li> <li>● The unit is in timer recording standby ("⊙" is on on the unit's display).</li> <li>● The remote control and main unit are using different codes. Change the code on the remote control.</li> </ul>	— 34 40
Cannot operate the TV.	<ul style="list-style-type: none"> <li>● Press [TV] to switch the remote control mode to TV.</li> <li>● Check the TV maker setting.</li> </ul>	— 16
Cannot operate the DVD.	<ul style="list-style-type: none"> <li>● Press [DVD] to switch the remote control mode to DVD.</li> </ul>	—
Television reception worsens after connecting the unit.	<ul style="list-style-type: none"> <li>● This can occur because the signals are being divided between the unit and the television. You can solve this with a signal booster, available from audio-visual suppliers. Consult your dealer if reception does not improve.</li> </ul>	—
Cannot eject cassette.	<ul style="list-style-type: none"> <li>● The unit is recording or in timer recording standby mode. If you need to eject the tape, press [⊙] first so "⊙" goes out.</li> </ul>	34

## Specific operation impossible or incorrect

It takes time before play starts. MP3	<ul style="list-style-type: none"> <li>● Play may take time to begin when an MP3 track has still picture data. Even after the track starts, the correct play time will not be displayed, however this is normal.</li> </ul>	—
Programmed items are not played. DVD-V	<ul style="list-style-type: none"> <li>● Some items will not be played even if you have programmed them.</li> </ul>	—
A menu screen appears during skip or search. VCD	<ul style="list-style-type: none"> <li>● This is normal for Video CDs.</li> </ul>	—
The on-screen menu shows "2" as a soundtrack option when [AUDIO] is pressed, but the audio does not change. DVD-A	<ul style="list-style-type: none"> <li>● Even if a second soundtrack isn't recorded, two numbers will normally be shown.</li> </ul>	—
Play restarts from the beginning of the track when soundtrack is changed. DVD-A	<ul style="list-style-type: none"> <li>● This is normal on DVD-Audio.</li> </ul>	—

## Subtitle

Subtitle position is wrong.	<ul style="list-style-type: none"> <li>● Adjust the position. ("Subtitle Position" in Display Menu)</li> </ul>	27
No subtitles.	<ul style="list-style-type: none"> <li>● Display the subtitles.</li> </ul>	20
The subtitles overlap closed captions recorded on discs.	<ul style="list-style-type: none"> <li>● Clear the subtitles.</li> </ul>	20

## Marker

Cannot add markers.	<ul style="list-style-type: none"> <li>● You cannot add markers while playing a play list or if the disc's play time doesn't appear on the unit's display.</li> </ul>	—
---------------------	---	---

## A-B repeat

Point B is automatically determined.	<ul style="list-style-type: none"> <li>● The end of an item becomes point B when it is reached.</li> </ul>	—
A-B repeat is automatically canceled.	<ul style="list-style-type: none"> <li>● A-B repeat is canceled when you press [QUICK REPLAY].</li> </ul>	—

## Menu

The Setup menu cannot be accessed.	<ul style="list-style-type: none"> <li>● Select "DVD/CD" as the source.</li> <li>● Cancel all group, program and random play.</li> </ul>	— 22
------------------------------------	--	---------



INFO

### Picture incorrect

Picture distorted.	<ul style="list-style-type: none"> <li>● Ensure that the unit is connected directly to the television, and is not connected through an A/V selector or other equipment.</li> </ul>	12
The television may display incorrectly or colors appear faded.	<ul style="list-style-type: none"> <li>● The unit and television are using different video systems. Use a multi-system or NTSC television.</li> <li>● The system used on the disc doesn't match your television. PAL discs cannot be played. This unit converts DVD-Audio recorded in PAL to NTSC for play, however, play may not function properly.</li> </ul>	—
The picture on the television disappears or stripes appear on the screen.	<ul style="list-style-type: none"> <li>● Mobile telephone chargers can cause some disturbance.</li> <li>● The location and orientation of the antenna are incorrect. If you are using an indoor antenna, change to an outdoor antenna.</li> <li>● The television antenna wire is too close to the unit. Separate the antenna wire of the television from the unit.</li> </ul>	43

### Disc picture incorrect

Picture size doesn't fit the screen.	<ul style="list-style-type: none"> <li>● Change "TV Aspect" in "Video" tab.</li> </ul>	28
	<ul style="list-style-type: none"> <li>● Use the television to change the aspect. If your television does not have that function, change "4:3 Aspect" in Display Menu.</li> </ul>	27
	<ul style="list-style-type: none"> <li>● Change the Zoom setting.</li> </ul>	20
Menus not displayed correctly.	<ul style="list-style-type: none"> <li>● Restore the zoom ratio to <math>\times 1.00</math>.</li> </ul>	20
	<ul style="list-style-type: none"> <li>● Set "Subtitle Position" in Display Menu to "0".</li> </ul>	27
	<ul style="list-style-type: none"> <li>● Set "4:3 Aspect" in Display Menu to "Normal".</li> </ul>	27
Auto zoom function does not work well.	<ul style="list-style-type: none"> <li>● Turn off TV's zoom function.</li> </ul>	—
	<ul style="list-style-type: none"> <li>● Use the other preset aspect ratios or manual adjustment.</li> </ul>	20
	<ul style="list-style-type: none"> <li>● Zoom function may not work well, especially in dark scenes and may not work depending on the type of disc.</li> </ul>	—

### VHS picture incorrect

The picture is noisy or is in black and white. Horizontal bars or lines run down the screen.	<ul style="list-style-type: none"> <li>● Adjust the tracking.</li> </ul>	31
	<ul style="list-style-type: none"> <li>● Make sure the television's input setting is correct.</li> </ul>	—
	<ul style="list-style-type: none"> <li>● The video heads are dirty: clean them with a head-cleaning cassette.</li> </ul>	52
	<ul style="list-style-type: none"> <li>● The video heads are worn: consult your dealer.</li> </ul>	—
	<ul style="list-style-type: none"> <li>● The tape is old or damaged.</li> </ul>	—
Picture is distorted when stilled or during slow-motion.	<ul style="list-style-type: none"> <li>● You cannot correctly play tapes recorded with other systems (e.g., PAL).</li> </ul>	—
	<ul style="list-style-type: none"> <li>● Some distortion is normal with tapes recorded using VP mode.</li> </ul>	—
The blue back appears during play.	<ul style="list-style-type: none"> <li>● You are playing a blank or poor quality part of the tape.</li> </ul>	—
	<ul style="list-style-type: none"> <li>● You can damage the unit if you play dirty or damaged tapes and this can cause the blue back to appear. Consult your dealer.</li> </ul>	—
The picture jiggles.	<ul style="list-style-type: none"> <li>● Adjust the vertical hold.</li> </ul>	31

### Progressive video

There is ghosting when progressive output is on.	<ul style="list-style-type: none"> <li>● Change "Video Output Mode" in Picture Menu to "480I". This problem is caused by the editing method or material used on DVD-Video, but should be corrected if you use interlace output.</li> </ul>	27
Pictures not in progressive output.	<ul style="list-style-type: none"> <li>● If the unit is connected to the television through VIDEO OUT or S-VIDEO OUT output will be interlace.</li> </ul>	—
	<ul style="list-style-type: none"> <li>● Press [SHIFT]+[PROGRESSIVE] on the main unit. Then, select "480P" in "Video Output Mode" in Picture Menu.</li> </ul>	18, 27
Closed captions not displayed.	<ul style="list-style-type: none"> <li>● When progressive output is on, closed captions will not be displayed.</li> </ul>	—

### Sound incorrect

Sound distorted.	<ul style="list-style-type: none"> <li>● Noise may occur when playing WMA files.</li> </ul>	—
Folders deeper than the eighth layer on a data CD are not displayed correctly.	<ul style="list-style-type: none"> <li>● Folders deeper than the eighth layer are displayed as the eighth layer.</li> </ul>	—
Effects do not work.	<ul style="list-style-type: none"> <li>● Some audio effects do not work or have less effect with some discs.</li> </ul>	—
	<ul style="list-style-type: none"> <li>● Multi Re-master and Dolby Pro Logic II do not work if you have changed the play speed.</li> </ul>	21
Humming heard during play.	<ul style="list-style-type: none"> <li>● An AC power supply cord or fluorescent light is near the subwoofer. Keep other appliances and cords away from the subwoofer.</li> </ul>	—
There is noise when playing a video tape.	<ul style="list-style-type: none"> <li>● Adjust the tracking.</li> </ul>	31
	<ul style="list-style-type: none"> <li>● The tape is old or damaged.</li> </ul>	—

### Listening to the radio

Noise is heard. "ST" flickers or doesn't light. Sound is distorted.	<ul style="list-style-type: none"> <li>● Adjust the position of the FM or AM antenna.</li> </ul>	—
	<ul style="list-style-type: none"> <li>● Use an outdoor antenna.</li> </ul>	43
A beat sound is heard.	<ul style="list-style-type: none"> <li>● Turn the television off or separate it from the unit.</li> </ul>	—
A low hum is heard during AM broadcasts.	<ul style="list-style-type: none"> <li>● Separate the antenna from other cables.</li> </ul>	—



Recording

<p>“” flashes when I try to start recording. Cannot record.</p>	<ul style="list-style-type: none"> <li>● If the erasure prevention tab has been removed, cover the hole with adhesive tape.</li> </ul>	5
<p>Timer recording doesn't record a program correctly.</p>	<ul style="list-style-type: none"> <li>● Check the clock and calendar.</li> <li>● Set the channel and start and end times correctly.</li> <li>● Be sure to press [Ⓢ] after programming to put the unit in timer recording standby.</li> <li>● Program times may be overlapped.</li> </ul>	— — 34 —
<p>Cannot record from other equipment.</p>	<ul style="list-style-type: none"> <li>● Press [^ CH] or [v CH] to Select “AU”.</li> <li>● Check the connections to the other equipment.</li> </ul>	33 33
<p>Black bands appear in the recording.</p>	<ul style="list-style-type: none"> <li>● Move the other equipment away from the television as it may be picking up interference.</li> </ul>	—
<p>The copy of a videotape or DVD is very poor.</p>	<ul style="list-style-type: none"> <li>● This unit complies with industry standards regarding the recording and duplication of copy-protected material. This includes commercial videotapes and DVDs. Consequently, copying not only infringes copyright laws but also presents serious technical difficulties. Even in cases where a copy can be made, the quality will be very poor.</li> </ul>	—

Unit display

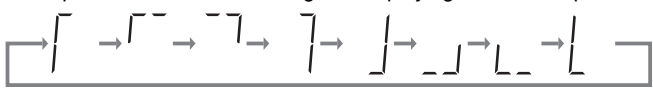
<p>The unit's display disappears or fades once the unit is turned off.</p>	<ul style="list-style-type: none"> <li>● The DISPLAY setting is set to “DIM” or “OFF” under OPTION from the VHS MENU. Select “BRIGHT” if you want the display bright all the time.</li> </ul>	40
<p>The tape counter isn't changing.</p>	<ul style="list-style-type: none"> <li>● The tape counter does not change while playing unrecorded parts.</li> </ul>  <ul style="list-style-type: none"> <li>● The display also appears like this if the tape is dirty or damaged. Consult your dealer if this is the case.</li> </ul>	— —
<p>“NoPLAY”</p>	<ul style="list-style-type: none"> <li>● You inserted a disc the unit cannot play; insert one it can.</li> <li>● You inserted a blank disc.</li> </ul>	6 —
<p>“NoDISC”</p>	<ul style="list-style-type: none"> <li>● You haven't inserted a disc; insert one.</li> <li>● You haven't inserted the disc correctly; insert it correctly.</li> </ul>	— 18
<p>“F61”</p>	<ul style="list-style-type: none"> <li>● Check and correct the speaker cord connections.</li> <li>● If this does not fix the problem, there is a power supply problem. Consult the dealer.</li> </ul>	11, 14
<p>“U11”</p>	<ul style="list-style-type: none"> <li>● Disc is dirty. Wipe it clean.</li> </ul>	6
<p>“U15”</p>	<ul style="list-style-type: none"> <li>● You inserted a DVD-R that has not been finalized.</li> </ul>	6
<p>“ERROR”</p>	<ul style="list-style-type: none"> <li>● Incorrect operation performed. Read the instructions and try again.</li> </ul>	—
<p>“U30”</p>	<ul style="list-style-type: none"> <li>● The remote control and main unit are using different codes. Change the code on the remote control.</li> </ul>	40
<p>“H□□”, “F□□” □□ stands for a number.</p>	<ul style="list-style-type: none"> <li>● Trouble may have occurred. The number following “H” or “F” depends on the status of the unit. Turn the unit off and then back to ON. Alternatively, turn the unit off, disconnect both AC power supply cords, and then reconnect them.</li> <li>● If the service numbers fail to clear, note the service number and contact a qualified service person.</li> </ul>	— —

Television display

<p>“”</p>	<ul style="list-style-type: none"> <li>● The operation is prohibited by the unit or disc.</li> </ul>	—
<p>“Cannot display group xx, content xx”</p>	<ul style="list-style-type: none"> <li>● You are trying to display incompatible contents.</li> </ul>	25
<p>“This disc may not be played in your region”</p>	<ul style="list-style-type: none"> <li>● You can only play DVD-Video if their region number is “1” or includes the same region number as the unit or if the DVD-Video is marked “ALL”.</li> </ul>	Cover
<p>No on-screen display.</p>	<ul style="list-style-type: none"> <li>● Select “On” in “On-Screen Messages” in “Display” tab.</li> <li>● Select “ON” in “OSD” of “OPTION” setting in the VHS MENU.</li> </ul>	29 40
<p>The menu is displayed in a different language.</p>	<ul style="list-style-type: none"> <li>● Select the preferred language in “Menus” in “Disc” tab.</li> <li>● Select the preferred language in “LANGUAGE” in the VHS MENU.</li> </ul>	28 38



Maintenance

Clean this unit with a soft, dry cloth.

- Never use alcohol, paint thinner or benzine to clean this unit.
- Before using chemically treated cloth, read the instructions that came with the cloth carefully.

Cleaning the video heads

Dirt on the video heads can cause poor recording and play.



To clean the heads, insert and eject a tape 5 to 10 times in succession.

If the picture does not improve, use an optional head-cleaning cassette (part number NV-TCL30PT). If the problem persists, seek advice from a qualified service person.

**■ AMPLIFIER SECTION**

<b>RMS output power, 10 % total harmonic distortion</b>	
1 kHz FL/FR	55 W per channel 6 Ω
1 kHz Center	160 W per channel 6 Ω
1 kHz SL/SR	55 W per channel 6 Ω
100 Hz Subwoofer	220 W per channel 4 Ω
<b>Total RMS Dolby Digital mode power</b>	600 W
<b>FTC output power, 1 % total harmonic distortion</b>	
120 Hz–20 kHz FL/FR	30 W per channel 6 Ω
120 Hz–20 kHz Center	110 W per channel 6 Ω
120 Hz–20 kHz SL/SR	30 W per channel 6 Ω
45 Hz–120 Hz Subwoofer	140 W per channel 4 Ω
<b>Total FTC power in Dolby Digital mode (Band 1 % THD)</b>	370 W
<b>Input sensitivity</b>	
AUX	250 mV
<b>Input impedance</b>	47 kΩ

**■ SPEAKER SECTION**

**Front/Surround speakers SB-FS520A**

<b>Type</b>	1 way, 1 speaker, Bass-ref.
<b>Speakers</b>	
Full range	6.5 cm (2½"), cone type, 6 Ω
<b>Input power</b>	60 W (Music)
<b>Output sound pressure level</b>	82 dB/W (1.0 m)
<b>Frequency range</b>	88 Hz–25 kHz (–16 dB) 100 Hz–22 kHz (–10 dB)
<b>Dimensions (W×H×D)</b>	90×180×112.4 mm (3 <sup>9</sup> / <sub>16</sub> "×7 <sup>3</sup> / <sub>32</sub> "×4 <sup>7</sup> / <sub>16</sub> ")
<b>Mass</b>	0.73 kg (1.61 lb.)

**Center speaker SB-PC820**

<b>Type</b>	1 way, 2 speaker, Bass-ref.
<b>Speakers</b>	
Full range	6.5 cm (2½"), cone type, 6 Ω
<b>Input power</b>	160 W (Music)
<b>Output sound pressure level</b>	83 dB/W (1.0 m)
<b>Frequency range</b>	97 Hz–25 kHz (–16 dB) 125 Hz–22 kHz (–10 dB)
<b>Dimensions (W×H×D)</b>	300×103×116.7 mm (11 <sup>13</sup> / <sub>16</sub> "×4 <sup>1</sup> / <sub>16</sub> "×4 <sup>19</sup> / <sub>32</sub> ")
<b>Mass</b>	1.31 kg (2.89 lb.)

**Subwoofer SB-WA820P**

<b>Type</b>	1 way, 1 speaker, Bass-ref.
<b>Speaker unit</b>	
Woofer	17 cm (6¾"), cone type, 4 Ω
<b>Input power</b>	220 W (Music)
<b>Output sound pressure level</b>	80 dB/W (1.0 m)
<b>Frequency range</b>	32 Hz–220 Hz (–16 dB) 36 Hz–190 Hz (–10 dB)
<b>Dimensions (W×H×D)</b>	209×360.5×463 mm (8 <sup>7</sup> / <sub>32</sub> "×14 <sup>7</sup> / <sub>32</sub> "×18 <sup>7</sup> / <sub>32</sub> ")
<b>Mass</b>	11.5 kg (25.4 lb.)

**■ DISC SECTION**

<b>Disc played</b>	(one layer per side)
<b>DVD-VIDEO/AUDIO</b>	8 cm/12 cm, single/double-sided, single/double layer
<b>CD/VCD/MP3/WMA</b>	8 cm/12 cm, CD-R/RW
<b>DVD-RAM/R (DVD-VIDEO formatted discs)</b>	
<b>HighMAT</b>	Level 2 (Audio and Image)
<b>Video</b>	
<b>Signal system</b>	NTSC
<b>Output level</b>	Composite video; 1 Vp-p (75 Ω) S-video; 1 Vp-p (Y), 0.286 Vp-p (C) (75 Ω) Component video; 1 Vp-p (Y) (75 Ω) 0.7 Vp-p (P <sub>B</sub> /C <sub>B</sub> , P <sub>R</sub> /C <sub>R</sub> ) (75 Ω)
<b>Audio</b>	
<b>Sampling frequency</b>	
CD	44.1 kHz
MP3	32 kHz, 44.1 kHz, 48 kHz
DVD	48 kHz, 96 kHz (video), 192 kHz (audio)
<b>Bitrate</b>	
MP3	32–320 kbps
<b>Decoding</b>	16/20/24 bit linear
<b>Pick up</b>	
<b>Beam Source</b>	Semiconductor Laser
<b>Wavelength</b>	
CD/VCD	785 nm
DVD	662 nm

<b>Number of channels</b>	5.1 ch (FL, FR, SL, SR, C, SW)
<b>Frequency response</b>	20 Hz–20 kHz (+1, –2 dB)
<b>Wow and flutter</b>	Less than possible measurement data
<b>Digital filter</b>	8 fs
<b>D/A converter</b>	Delta sigma DAC

**■ VHS SECTION**

<b>Video recording system</b>	2 rotary heads, helical scanning system
<b>Video heads</b>	4 heads
<b>Audio heads</b>	2 heads
<b>Tape speed</b>	SP; 33.35 mm/s, EP; 11.12 mm/s, VP; 6.66 mm/s
<b>Tape format</b>	VHS tape
<b>Recording/playback time</b>	SP; 120 min. with NV-T120 EP; 360 min. with NV-T120
<b>FF/REW time</b>	Approx. 54 s. with NV-T120 (FF/REW) Approx. 36 s. with NV-T120 (JET REW)

**VIDEO**

<b>Television system</b>	EIA; Standard (525 lines, 60 fields), NTSC color signal
<b>Modulation system</b>	Luminance; FM azimuth recording Color signal; converted subcarrier phase shift recording
<b>Input level</b>	VIDEO IN (PHONO); 1 Vp-p, 75 Ω
<b>Output level</b>	VIDEO OUT (PHONO); 1 Vp-p, 75 Ω
<b>Antenna receive input</b>	VHF 2–13 CH, 75 Ω UHF 14–69 CH, 75 Ω CATV 5A and A-5–EEE CH, 75 Ω

**AUDIO**

<b>Input level</b>	AUDIO IN (PHONO); –10 dBV, 47 kΩ
<b>Output level</b>	AUDIO OUT (PHONO); –8 dBV, 1 kΩ
<b>Audio track</b>	1 track (normal-mono only), 2 channels (Hi-Fi sound stereo)
<b>Video horizontal resolution</b>	Color; more than 200 lines
<b>Signal-to-Noise ratio</b>	Video; more than 40 dB/SP Audio; more than 60 dB/Hi-Fi
<b>Audio frequency response</b>	20 Hz–20 kHz/Hi-Fi
<b>Wow and flutter</b>	0.005 % Wrms/Hi-Fi

**■ FM TUNER SECTION**

<b>Frequency range</b>	87.9–107.9 MHz (200-kHz step) 87.5–108.0 MHz (100-kHz step)
<b>Sensitivity</b>	2.5 μV (IHF)
<b>S/N 26 dB</b>	2.2 μV
<b>Antenna terminals</b>	75 Ω (unbalanced)
<b>Preset station</b>	15

**■ AM TUNER SECTION**

<b>Frequency range</b>	520–1710 kHz (10-kHz step)
<b>AM Sensitivity S/N 20 dB at 1000 kHz</b>	560 μV/m
<b>Preset station</b>	15

**■ GENERAL**

<b>Power supply</b>	AC 120 V, 60 Hz
<b>Power consumption</b>	
Main unit	38 W
<b>Subwoofer SB-WA820P</b>	250 W
<b>Dimensions (W×H×D)</b>	430×105×352 mm (16 <sup>15</sup> / <sub>16</sub> "×4 <sup>1</sup> / <sub>8</sub> "×13 <sup>7</sup> / <sub>8</sub> ")
<b>Mass</b>	5 kg (11 lb.)

**Power consumption in standby mode**

BRIGHT mode	Approx. 3.5 W
DIM mode	Approx. 3.2 W
OFF mode	Approx. 1.9 W

**Note**

- Specifications are subject to change without notice. Mass and dimensions are approximate.
- Total harmonic distortion is measured by the digital spectrum analyzer.



INFO

# Limited Warranty (ONLY FOR U.S.A.)

Panasonic Consumer Electronics Company,  
Division of Matsushita Electric Corporation of America  
One Panasonic Way Secaucus, New Jersey 07094

Panasonic Sales Company, Division of Matsushita Electric  
of Puerto Rico, Inc.,  
Ave. 65 de Infantería, Km. 9.5  
San Gabriel Industrial Park, Carolina, Puerto Rico 00985

## Panasonic Audio Products Limited Warranty

### Limited Warranty Coverage

If your product does not work properly because of a defect in materials or workmanship, Panasonic Consumer Electronics Company or Panasonic Sales Company (collectively referred to as "the warrantor") will, for the length of the period indicated on the chart below, which starts with the date of original purchase ("warranty period"), at its option either (a) repair your product with new or refurbished parts, or (b) replace it with a new or a refurbished product. The decision to repair or replace will be made by the warrantor.

Product or Part Name	Parts	Labor
Audio Products (except items listed below)	One (1) year	One (1) year
All Audio Racks (cabinets)	Thirty (30) days	Not Applicable
Technics Stand Alone Speakers, Subwoofer Speakers	Three (3) years	Three (3) years
USB Reader-Writer, Personal Computer Card Adapters (in exchange for defective item)	One (1) year	Not Applicable
Accessories: Headphones, Cartridges, Microphones, Adapters	Ninety (90) days	Ninety (90) days
Rechargeable Batteries, DVD-R/-RAM Discs (in exchange for defective item)	Ten (10) days	Not Applicable
SD Memory Cards, Rechargeable Battery Packs (in exchange for defective item)	Ninety (90) days	Not Applicable

During the "Labor" warranty period there will be no charge for labor. During the "Parts" warranty period, there will be no charge for parts. You must carry-in or mail-in your product during the warranty period. If non-rechargeable batteries are included, they are not warranted. This warranty only applies to products purchased and serviced in the United States or Puerto Rico. This warranty is extended only to the original purchaser of a new product which was not sold "as is". A purchase receipt or other proof of the original purchase date is required for warranty service.

### Carry-In or Mail-In Service

For Carry-In or Mail-In Service in the United States call 1-800-211-PANA (1-800-211-7262) or visit Panasonic web site: <http://www.panasonic.com>

For assistance in Puerto Rico call Panasonic Sales Company (787)-750-4300 or fax (787)-768-2910.

### Limited Warranty Limits And Exclusions

This warranty ONLY COVERS failures due to defects in materials or workmanship, and DOES NOT COVER normal wear and tear or cosmetic damage. The warranty ALSO DOES NOT COVER damages which occurred in shipment, or failures which are caused by products not supplied by the warrantor, or failures which result from accidents, misuse, abuse, neglect, mishandling, misapplication, alteration, faulty installation, set-up adjustments, misadjustment of consumer controls, improper maintenance, power line surge, lightning damage, modification, or commercial use (such as in a hotel, office, restaurant, or other business), rental use of the product, service by anyone other than a Factory Servicenter or other Authorized Servicer, or damage that is attributable to acts of God.

**THERE ARE NO EXPRESS WARRANTIES EXCEPT AS LISTED UNDER "LIMITED WARRANTY COVERAGE". THE WARRANTOR IS NOT LIABLE FOR INCIDENTAL OR CONSEQUENTIAL DAMAGES RESULTING FROM THE USE OF THIS PRODUCT, OR ARISING OUT OF ANY BREACH OF THIS WARRANTY.** (As examples, this excludes damages for lost time, travel to and from the servicer, loss of media or images, data or other memory content. The items listed are not exclusive, but are for illustration only.) **ALL EXPRESS AND IMPLIED WARRANTIES, INCLUDING THE WARRANTY OF MERCHANTABILITY, ARE LIMITED TO THE PERIOD OF THE LIMITED WARRANTY.**

Some states do not allow the exclusion or limitation of incidental or consequential damages, or limitations on how long an implied warranty lasts, so the exclusions may not apply to you. This warranty gives you specific legal rights and you may also have other rights which vary from state to state. If a problem with this product develops during or after the warranty period, you may contact your dealer or Servicenter. If the problem is not handled to your satisfaction, then write to the warrantor's Consumer Affairs Department at the addresses listed for the warrantor.

**PARTS AND SERVICE WHICH ARE NOT COVERED BY THIS LIMITED WARRANTY ARE YOUR RESPONSIBILITY.**

## Customer Services Directory

Obtain Product Information and Operating Assistance; locate your nearest Dealer or Servicenter; purchase Parts and Accessories; or make Customer Service and Literature requests by visiting our Web Site at:

<http://www.panasonic.com/support>

or, contact us via the web at:

<http://www.panasonic.com/contactinfo>

You may also contact us directly at:

1-800-211-PANA (7262),

Monday-Friday 9 am-9 pm; Saturday-Sunday 10 am-7 pm, EST.

For hearing or speech impaired TTY users, TTY : 1-877-833-8855

## Accessory Purchases

Purchase Parts, Accessories and Instruction Books online for all Panasonic Products by visiting our Web Site at:

<http://www.pasc.panasonic.com>

or, send your request by E-mail to:

[npcparts@panasonic.com](mailto:npcparts@panasonic.com)

You may also contact us directly at:

1-800-332-5368 (Phone) 1-800-237-9080 (Fax Only) (Monday – Friday 9 am to 8 pm, EST.)

Panasonic Services Company

20421 84th Avenue South, Kent, WA 98032

(We Accept Visa, MasterCard, Discover Card, American Express, and Personal Checks)

For hearing or speech impaired TTY users, TTY : 1-866-605-1277

## Service in Puerto Rico

Matsushita Electric of Puerto Rico, Inc. Panasonic Sales Company

Factory Servicenter:

Ave. 65 de Infantería, Km. 9.5, San Gabriel Industrial Park, Carolina, Puerto Rico 00985

Phone (787)750-4300, Fax (787)768-2910



INFO

# Limited Warranty (ONLY FOR CANADA)

Panasonic Canada Inc.

5770 Ambler Drive, Mississauga, Ontario L4W 2T3

## PANASONIC PRODUCT—LIMITED WARRANTY

Panasonic Canada Inc. warrants this product to be free from defects in material and workmanship and agrees to remedy any such defect for a period as stated below from the date of original purchase.

**COMBINATION DVD player/VCR One (1) year, parts and labour**

### LIMITATIONS AND EXCLUSIONS

This warranty does not apply to products purchased outside Canada or to any product which has been improperly installed, subjected to usage for which the product was not designed, misused or abused, damaged during shipping, or which has been altered or repaired in any way that affects the reliability or detracts from the performance, nor does it cover any product which is used commercially. Dry cell batteries are also excluded from coverage under this warranty.

This warranty is extended to the original end user purchaser only. A purchase receipt or other proof of date of original purchase is required before warranty service is performed.

**THIS EXPRESS, LIMITED WARRANTY IS IN LIEU OF ALL OTHER WARRANTIES, EXPRESS OR IMPLIED, EXCLUDING ANY IMPLIED WARRANTIES OF MERCHANTABILITY OR FITNESS FOR A PARTICULAR PURPOSE.**

**IN NO EVENT WILL PANASONIC CANADA INC. BE LIABLE FOR ANY SPECIAL, INDIRECT OR CONSEQUENTIAL DAMAGES.**

In certain instances, some jurisdictions do not allow the exclusion or limitation of incidental or consequential damages, or the exclusion of implied warranties, so the above limitations and exclusions may not be applicable.

### WARRANTY SERVICE

**For product operation and information assistance**, please contact your Dealer or our Customer Care Centre at: Telephone #: (905) 624-5505  
Fax #: (905) 238-2360 Web: [www.panasonic.ca](http://www.panasonic.ca)

**For product repairs**, please contact one of the following:

- Your Dealer who will inform you of an authorized Servicentre nearest you.
- Our Customer Care Centre at (905) 624-5505 or [www.panasonic.ca](http://www.panasonic.ca)
- A Panasonic Factory Servicentre listed below:

#### Richmond, British Columbia

Panasonic Canada Inc.  
12111 Riverside Way  
Richmond, BC  
V6W 1K8  
Tel: (604) 278-4211  
Fax: (604) 278-5627

#### Calgary, Alberta

Panasonic Canada Inc.  
6835-8<sup>th</sup> St. N. E.  
Calgary, AB  
T2E 7H7  
Tel: (403) 295-3955  
Fax: (403) 274-5493

#### Mississauga, Ontario

Panasonic Canada Inc.  
5770 Ambler Dr.  
Mississauga, ON  
L4W 2T3  
Tel: (905) 624-8447  
Fax: (905) 238-2418

#### Lachine, Québec

Panasonic Canada Inc.  
3075, rue Louis A. Amos  
Lachine, QC  
H8T 1C4  
Tel: (514) 633-8684  
Fax: (514) 633-8020

### IF YOU SHIP THE PRODUCT TO A SERVICENTRE

Carefully pack and send prepaid, adequately insured and preferably in the original carton.  
Include details of the defect claimed, and proof of date of original purchase.

## Product Service

- 1. Damage requiring service**—The unit should be serviced by qualified service personnel if:
  - (a) The AC power supply cord or AC adaptor has been damaged; or
  - (b) Objects or liquids have gotten into the unit; or
  - (c) The unit has been exposed to rain; or
  - (d) The unit does not operate normally or exhibits a marked change in performance; or
  - (e) The unit has been dropped or the cabinet damaged.
- 2. Servicing**—Do not attempt to service the unit beyond that described in these operating instructions. Refer all other servicing to authorized servicing personnel.
- 3. Replacement parts**—When parts need replacing ensure the servicer uses parts specified by the manufacturer or parts that have the same characteristics as the original parts. Unauthorized substitutes may result in fire, electric shock, or other hazards.
- 4. Safety check**—After repairs or service, ask the servicer to perform safety checks to confirm that the unit is in proper working condition.

The servicer will require all components to service your system.  
Therefore, should service ever be necessary, be sure to bring the entire system.

### Product information

For product information or assistance with product operation:

In the U.S.A., refer to "Customer Services Directory" on page 54.

In Canada, contact the Panasonic Canada Inc. Customer Care Centre at 1-800-561-5505, or visit the website ([www.panasonic.ca](http://www.panasonic.ca)), or an authorized Servicentre closest to you.



INFO

## Common

Batteries.....	4
Center Focus .....	44
Cleaning	
Main unit .....	52
Video heads.....	52
Connection	
Antennas.....	14
Cable TV .....	48
LINE IN/OUT.....	33, 47
Optional antenna connection .....	49
Speakers.....	11
Subwoofer.....	11
Television .....	12
Custom Sound Memory .....	45
Demonstration .....	14
Dolby Pro Logic.....	44
Dolby Pro Logic II .....	44
Down-mixing .....	45
Headphones .....	46
Muting .....	46
Remote control mode .....	7
Sleep timer .....	46
Sound field control .....	44
Source selector.....	7, 9
Speaker level adjustments .....	45
Subwoofer level.....	45
Super Surround .....	44

## DVD

A-B repeat.....	27
All group play .....	22
CD mode.....	21
COMPONENT VIDEO .....	13
Data discs .....	24
Dialogue Enhancer .....	27
HDCD .....	6
HighMAT .....	6, 25, 29
JPEG .....	25
Marker.....	26, 27
MP3 .....	25
Multi Re-master .....	21
Navigation menus .....	24
On-Screen Menu .....	26–27
Page skip .....	21
Picture mode.....	27
Play list.....	25
Play speed .....	27
Position memory .....	20
Program play .....	22
Progressive .....	13, 18
Quick replay .....	21
QUICK SETUP .....	17, 29
Random play.....	23
Ratings.....	28
Region number .....	Cover
Repeat play .....	23
Rotate picture .....	26

Settings.....	28–29
Speaker delay time .....	29
Subtitle.....	20
S-VIDEO .....	13
WMA.....	24, 25
Zoom .....	20

## VHS

Auto bilingual choice function .....	41
Categories .....	37
Clock setting	
Auto clock setting.....	15, 38
Manual clock setting .....	38
Jet Navigator.....	36, 40
Jet rewind .....	30
Jet search .....	30, 40
MTS .....	40
On-screen display .....	41
Picture mode .....	31
Recording	
LINE IN .....	33
Timer recording .....	34
TV program.....	32
Remocon code .....	40
Repeat play.....	31
SAP .....	41
Settings.....	38–41
SQPB.....	5
Tape counter .....	41
Tape length .....	40
Tape speed	
Auto SP/EP change .....	35
EP .....	32
LP .....	32
SP .....	32
VP .....	32
Tape's tab .....	5
Tracking .....	31
TV channel tuning	
Antenna system.....	39
Auto tuning .....	39
Manual tuning .....	39
Plug-in Auto Tuning.....	15
Vertical locking adjustment .....	31
VHS Index Search System (VISS).....	37

## TUNER

AM	
Antenna connection.....	14, 43
FM	
Antenna connection.....	14, 43
Antenna plug .....	43
Frequency step.....	42

## TV

Connection .....	12, 13
TV maker setting.....	16
TV operation .....	16



**Panasonic Consumer Electronics Company, Division of Matsushita Electric Corporation of America**  
 One Panasonic Way Secaucus,  
 New Jersey 07094  
<http://www.panasonic.com>

**Panasonic Sales Company, Division of Matsushita Electric of Puerto Rico, Inc. ("PSC")**  
 Ave. 65 de Infantería, Km. 9.5  
 San Gabriel Industrial Park, Carolina,  
 Puerto Rico 00985

**Panasonic Canada Inc.**  
 5770 Ambler Drive  
 Mississauga, Ontario  
 L4W 2T3  
[www.panasonic.ca](http://www.panasonic.ca)

